

MATLAB EXPO

Modeling Radar and Wireless Coexistence

Giorgia Zucchelli, MathWorks



Kirsten McCane, MathWorks



Babak Memarzadeh, MathWorks





MathWorks 

@MathWorks

Share the EXPO experience
#MATLABEXPO



Airports with Low-Visibility Landings in 5G Deployment



Aircraft Category - % Approved to Land

Approved Airport Count by Aircraft Model

No Airport Filter Applied - Select Point on Map to Apply Filter

Green - Greater than 90% of Aircraft Models Available to Land



Yellow - 50%-89% of Aircraft Models Available to Land

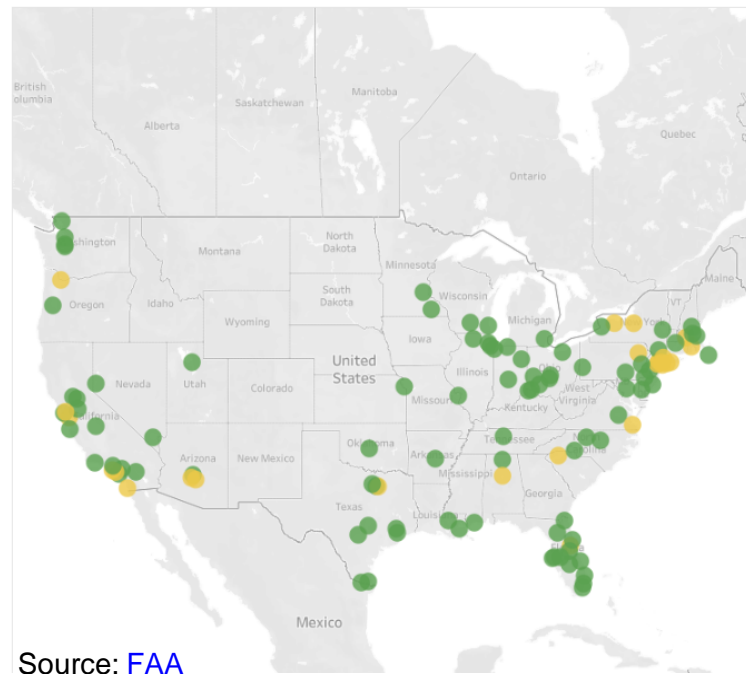
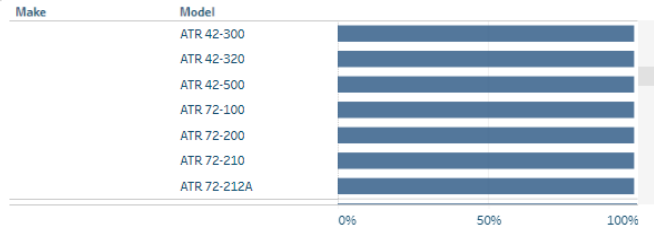

State	Green - Greater than 90% of Aircraft Models Available to Land	Yellow - 50%-89% of Aircraft Models Available to Land
AL	1	1
AR	1	0
AZ	1	2
CA	11	5
CT	1	0
DE	1	0
FL	12	1
IL	3	0
IN	4	0

Airport	Count	%
ALBANY INTL	01/19	95%
	10/28	81%
ATLANTIC CITY INTL	04/22	100%
	13/31	81%
AUSTIN-BERGSTROM INTL	18L/36R	95%
	18R/36L	95%
BALTIMORE/WASHINGTON INTL THURGOOD MARSHALL	10/28	100%
	15L/33R	100%
	15R/33L	100%
BATON ROUGE METRO, RYAN FLD	04L/22R	100%
	04R/22L	100%
	13/31	100%

Source: [FAA](#)

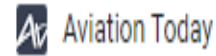

FAA Issues New Radar Altimeter 5G C-Band Risk Assessment ...

... interference issues facing aircraft radar altimeter systems two weeks ahead of the planned launch of new 5G C-Band wireless networks.



Source: [Aviation Today](#)

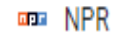

Boeing and Airbus urge a delay in 5G wireless service over ...

The companies have expressed concern that 5G, which operates on a frequency close to that used by aircraft systems such as radio altimeters,...



Source: [NPR](#)

Use modeling and simulation to analyze the effects of interference between radar and wireless communications systems



Increasing Congestion in the RF Spectrum

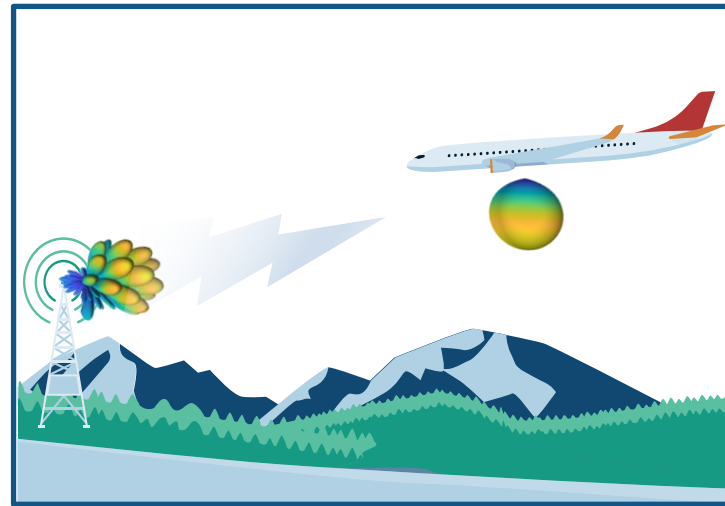

Scenario Modeling for Radar and Wireless Coexistence

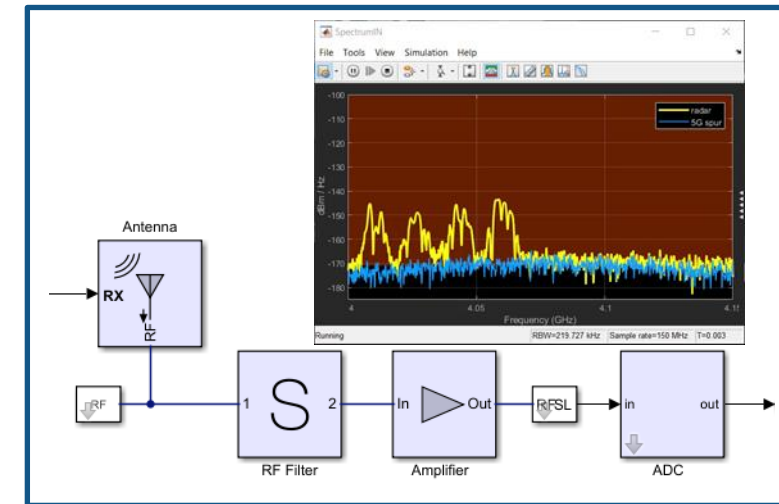

Analyze and Simulate in the RF Domain

Increasing Congestion in the RF Spectrum

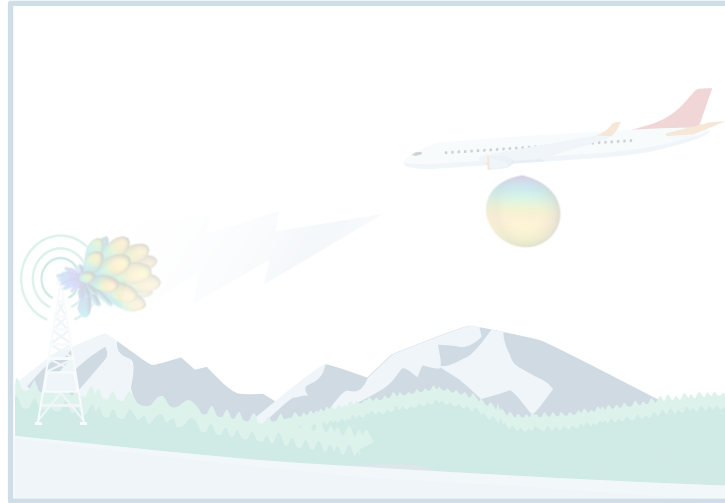

5G applications drive demanding data rate & efficiency requirements

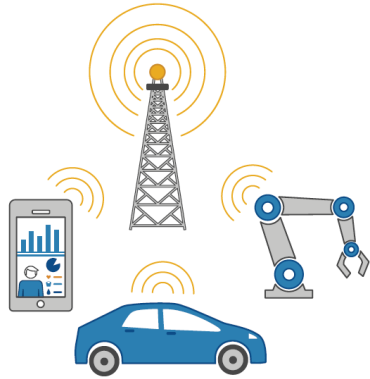

New Applications

4K and 8K 360° Video
 Virtual Reality
 Connected Vehicles
 Internet of Things



5G Requirements / Use Cases

Enhanced mobile broadband (>10 Gbps)
 Ultra low latency (<1 ms)
 Massive machine-type communication (>1e5 devices)



Technical Solutions

Increased bandwidth
 Better spectral efficiency
 Flexible air interface
 Densification



Higher Frequency Bands

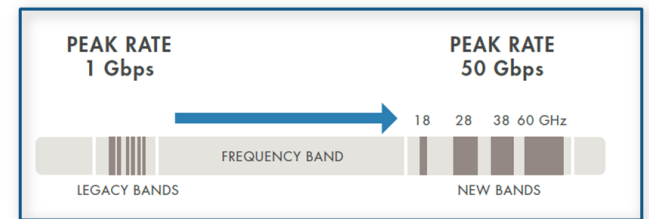

Higher frequency operations result in propagation challenges

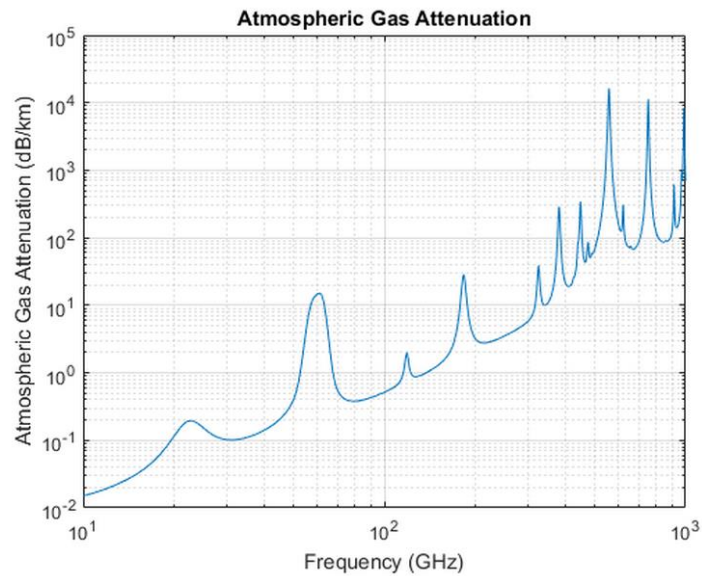

Signal Attenuation

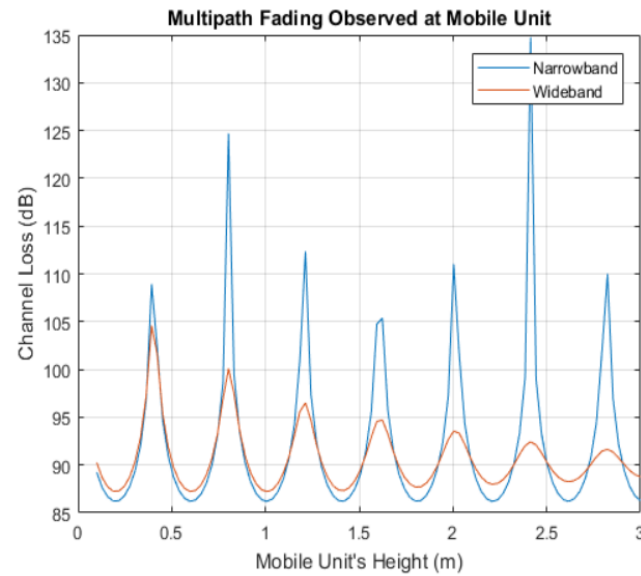

Wideband performance

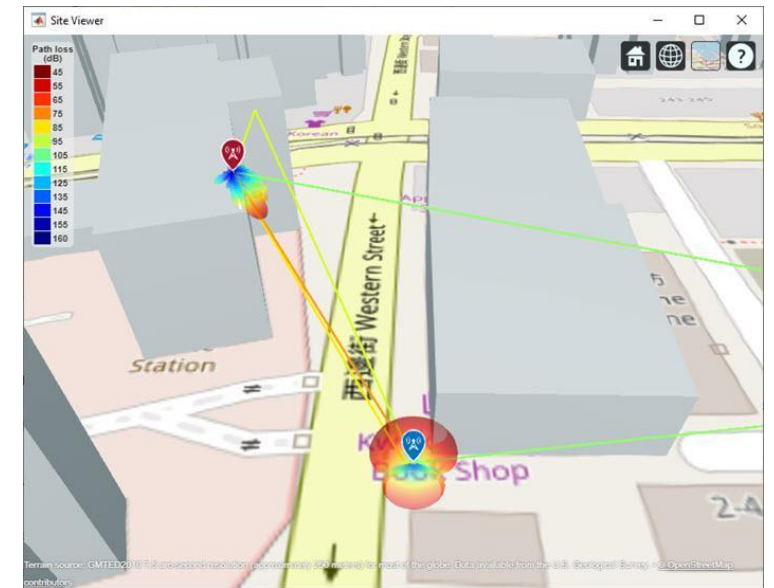

Scatterer-rich propagation

Shared spectrum operations present interference challenges

LTE  **Custom**

5G

 **Satellite**

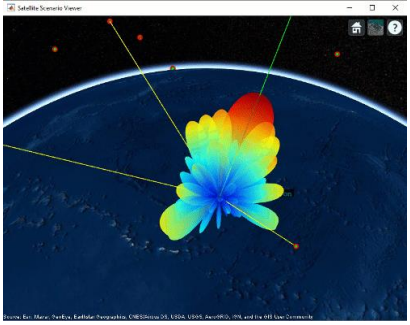

Communications

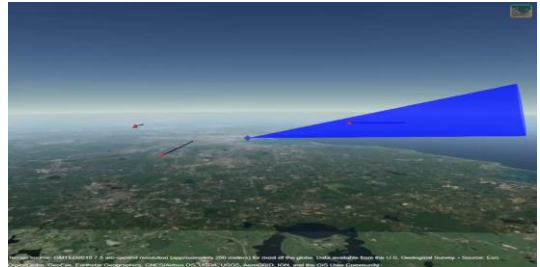
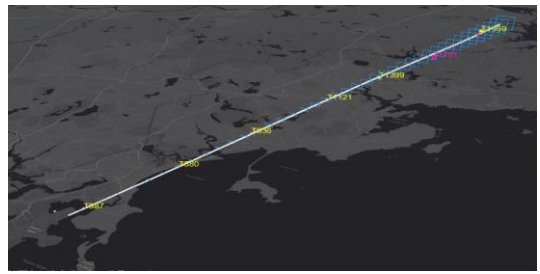
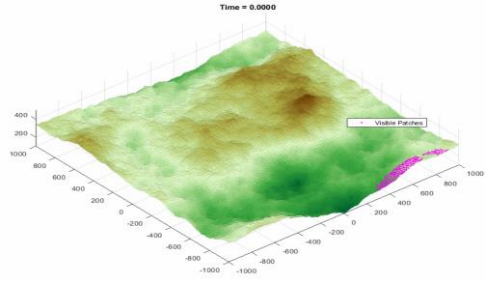



Radar



<https://www.5gtechnologyworld.com/>

Aviation Today
FAA Issues New Radar Altimeter 5G C-Band Risk Assessment ...
 ... interference issues facing aircraft radar altimeter systems two weeks ahead of the planned launch of new 5G C-Band wireless networks.
 3 weeks ago



NPR
Boeing and Airbus urge a delay in 5G wireless service over ...
 The companies have expressed concern that 5G, which operates on a frequency close to that used by aircraft systems such as radio altimeters, ...
 3 weeks ago



Interference

Signal-level and power-level analysis can help with planning

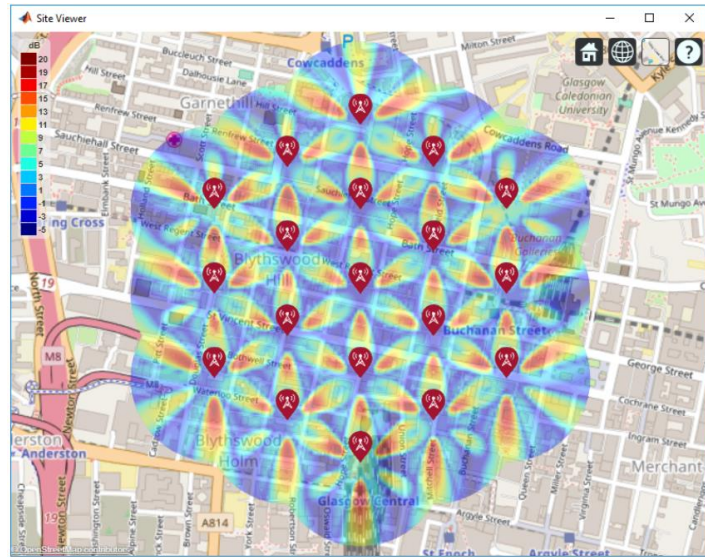
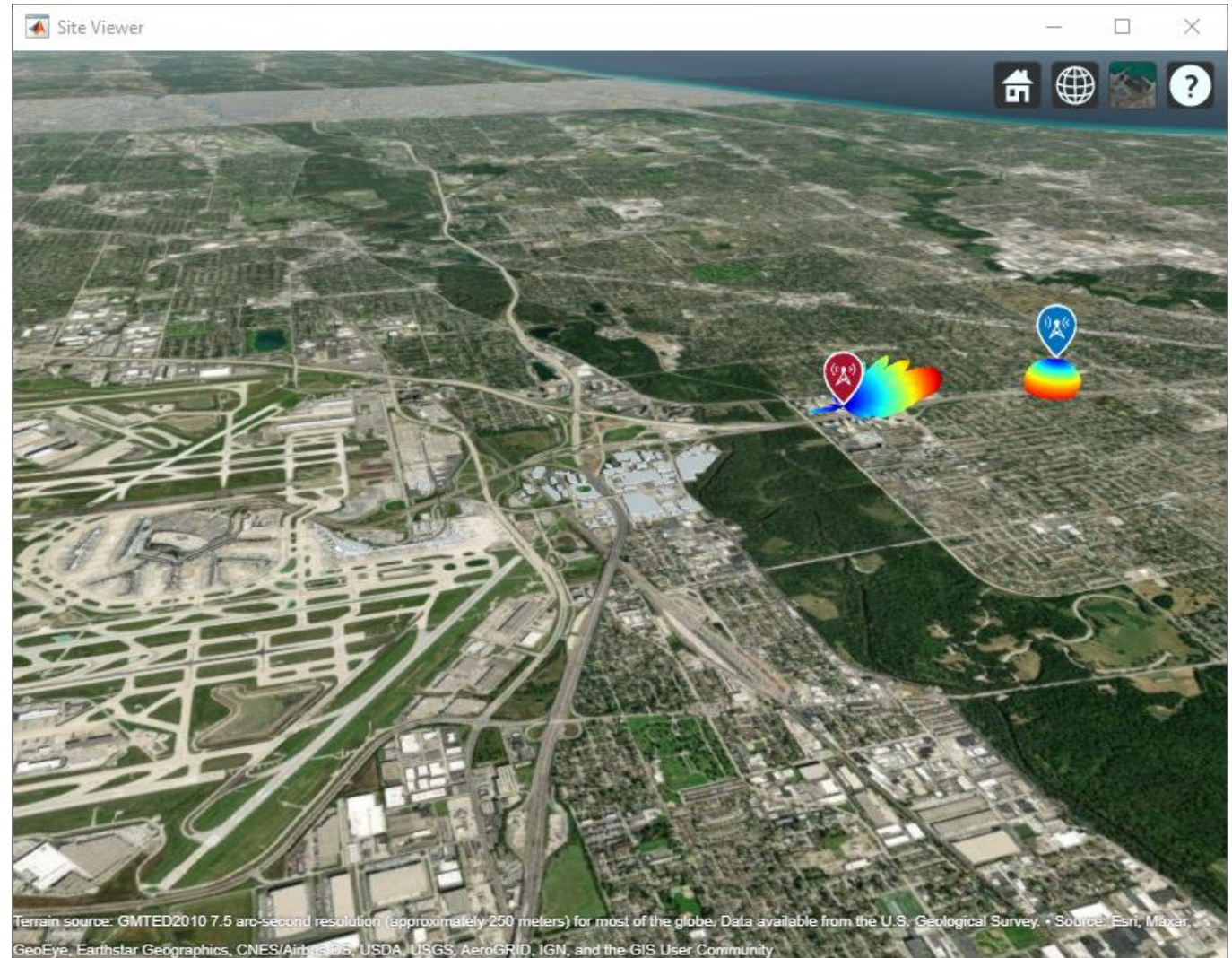
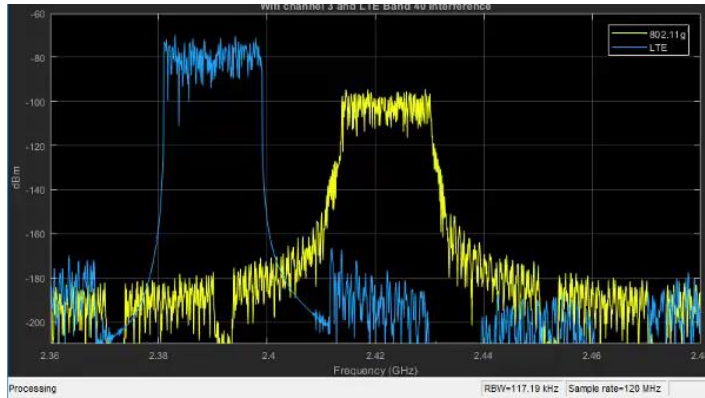

Scenario Modeling for Radar and Wireless Coexistence

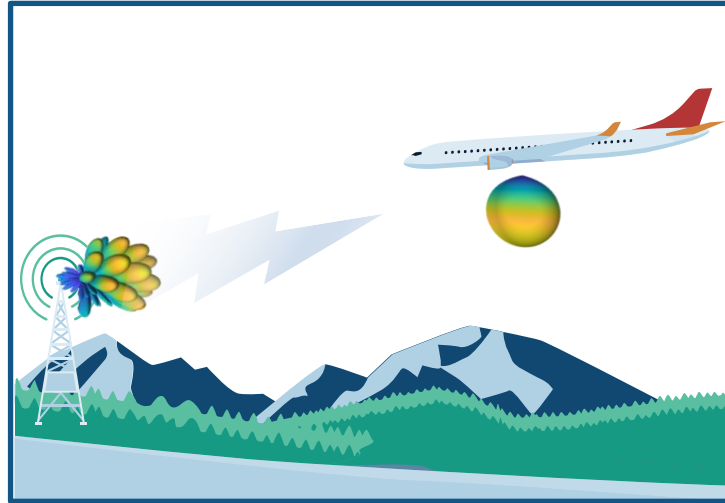

Typical radar scenario modeling workflow

Model Platforms
and Targets

Model Surfaces
and Clutter

Model Trajectories

Model Sensors

Simulate Scenarios

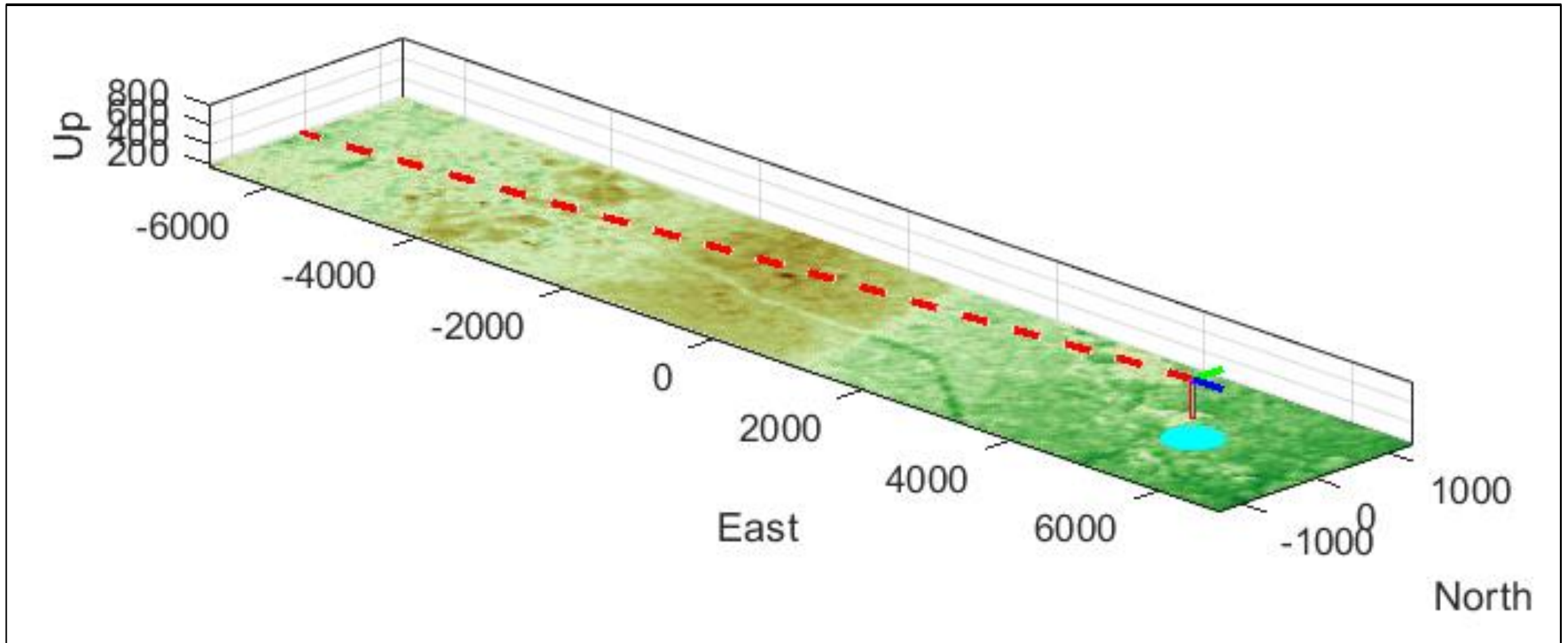

Model the radar altimeter sensor

Parameter	Value
Center Frequency	4.3 GHz
PRF	143 Hz
Chirp Bandwidth	150 MHz

```
RadarAltWaveform = phased.FMCWWaveform( ...
    'SweepBandwidth', RadarAlt.ChirpBW, ...
    'SampleRate', RadarAlt.fs, ...
    'SweepTime', RadarAlt.SweepTime, ...
    'OutputFormat', 'Sweeps');
```

```
RadarAltTransmitter = phased.Transmitter('PeakPower', ...
    RadarAlt.TransmitterPower);
```

```
cp = Beamwidth2CosiePower(RadarAlt.AntennaBeamWidth, RadarAlt.fc);
AntennaElement = phased.CosineAntennaElement("CosinePower", cp);
RadarAltAntenna = phased.ConformalArray('Element', AntennaElement);
RadarAltRadiator = phased.Radiator('OperatingFrequency', RadarAlt.fc, ...
    'Sensor', RadarAltAntenna);
```

```
RadarAltCollector = phased.Collector('OperatingFrequency', RadarAlt.fc, ...
    'Sensor', RadarAltAntenna);
```

```
RadarAltReceiver = phased.ReceiverPreamp('SampleRate', RadarAlt.fs, ...
    'NoiseFigure', RadarAlt.NF);
```

```
RadarAltSensor = radarTransceiver('Waveform', RadarAltWaveform, ...
    'Transmitter', RadarAltTransmitter, ...
    'TransmitAntenna', RadarAltRadiator, ...
    'ReceiveAntenna', RadarAltCollector, ...
    'Receiver', RadarAltReceiver, 'MountingAngles', [0 -90 0], ...
    'NumRepetitions', RadarAlt.numSweep);
```

Simulate the scenario and generate IQ signal

```

while advance(scene)
    iqsig = receive(scene);

    xr = dechirp(iqsig{:},refSig);

    xr = pulsint(xr,'coherent');

    fb_rng = rootmusic(xr,1,RadarAlt.fs);

    MeasuredAltitude = beat2range(fb_rng, ...
        RadarAlt.SweepSlope,c);
end

```

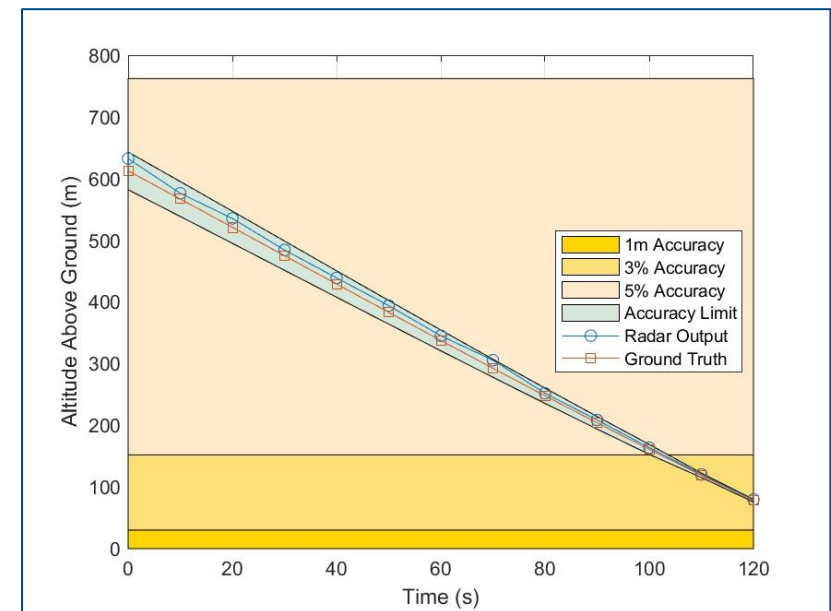
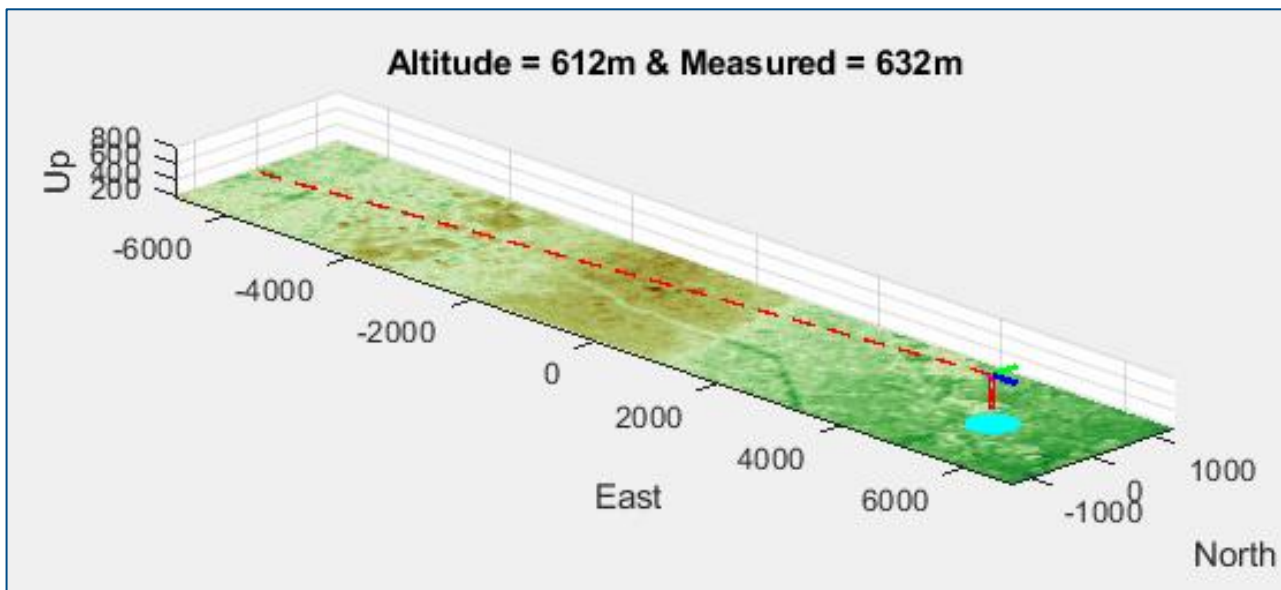
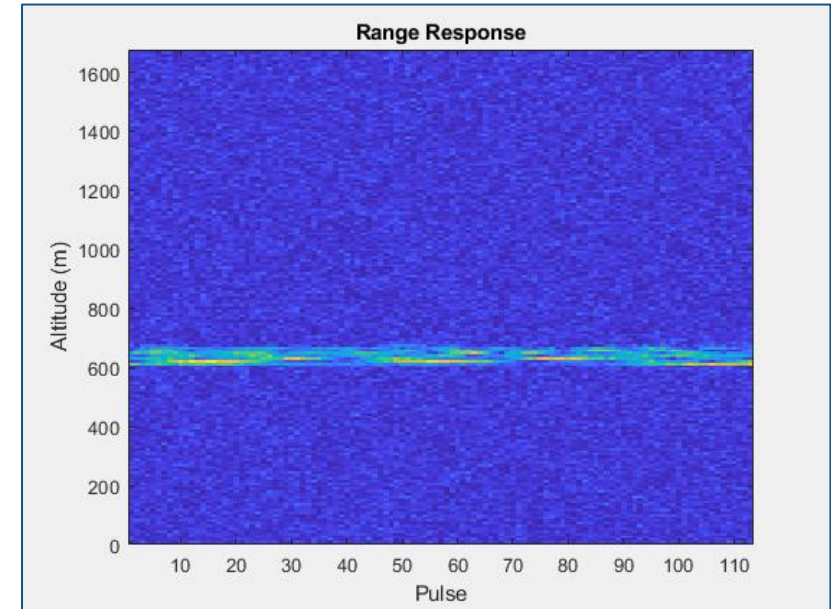

Model the base stations close to the flight path

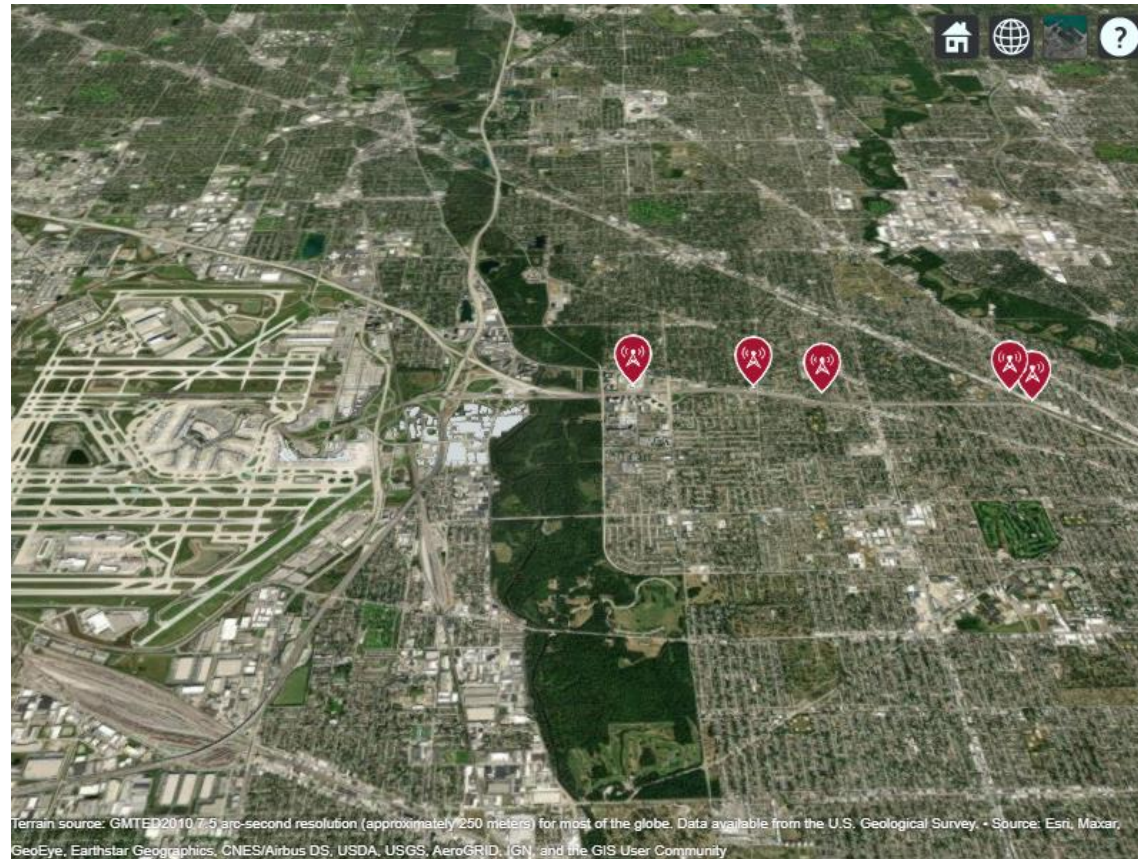

Waveform

Antenna
Array

Propagation
Channel

Generate 5G signal with the wireless waveform generator App

Wireless Waveform Generator - Spectrum Analyzer

GENERATOR TRANSMITTER

FILE WAVEFORM TYPE GENERATION

5G Downlink

Label: Carrier1

Frequency range: FR1 (410 MHz...)

Channel bandwidth (MHz): 50

Cell identity: 1

Subframes: 10

Windowing (%): 0

Sample rate source: Auto

Filtering Configuration

Filtering: None

SCS Carriers

Subcarrier Spacing	Grid Size (RB)	Grid Start (RB)
15 kHz	270	3

Bandwidth Parts

Cyclic Prefix	BWP Size (RB)	BWP Start (RB)	Label
Normal	270	3	3 BWP1

Resource Grid (BWP#1)

PDSCH1 slot:5 RB:261

BWP 1 in Carrier (SCS = 15 kHz)

Carrier RB

Slots

Legend: PDCCH, PDSCH, CORESET, SS Burst, CSI-RS

Spectrum Analyzer

Channel View

Stopped | RBW=60 kHz | Sample rate=61.44 MHz | T=0.0098994

Completed generation of Downlink waveform.

Model base station antenna with NR rectangular panel array

5G Antenna Array
(3GPP TR 38.901)

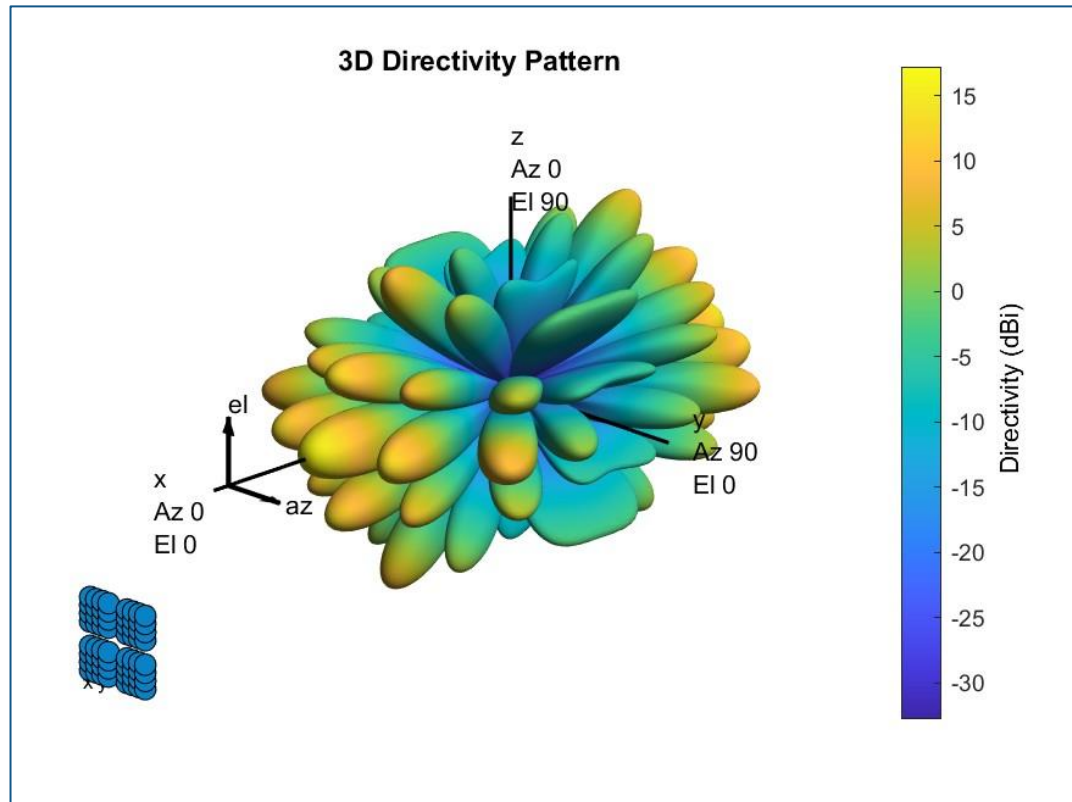

Maximize directivity for
worst case scenario

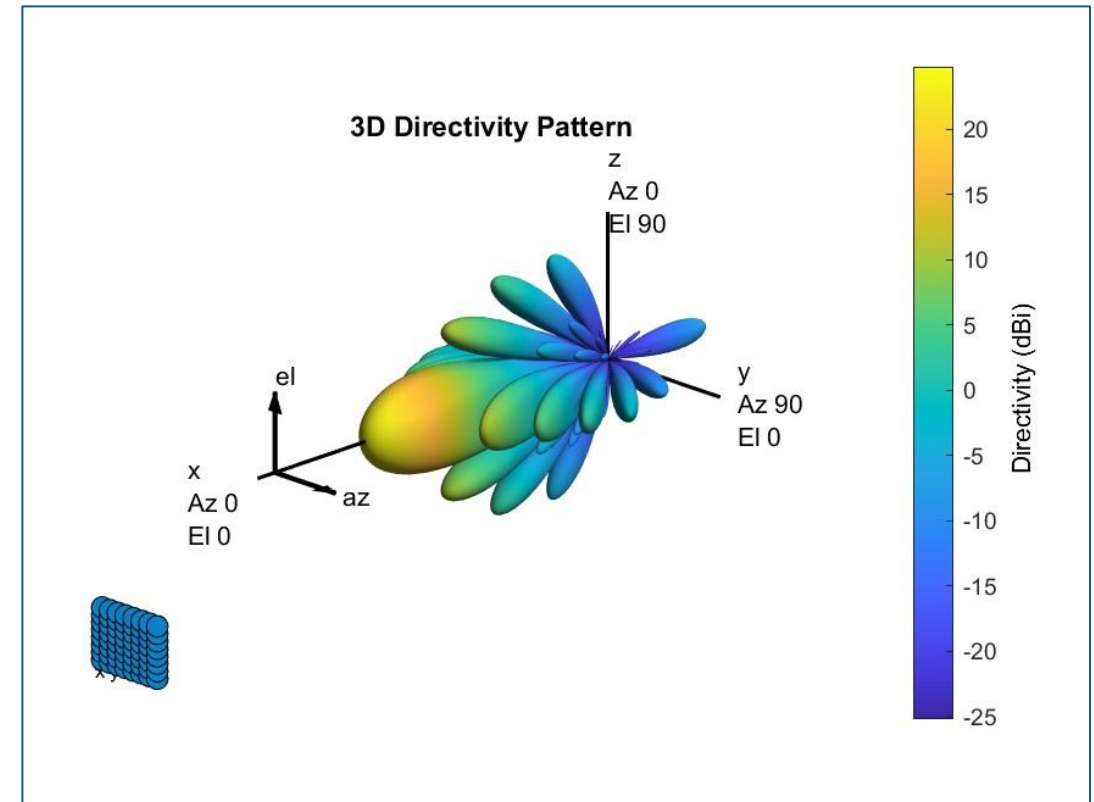

Simulate radar and interference signal propagation

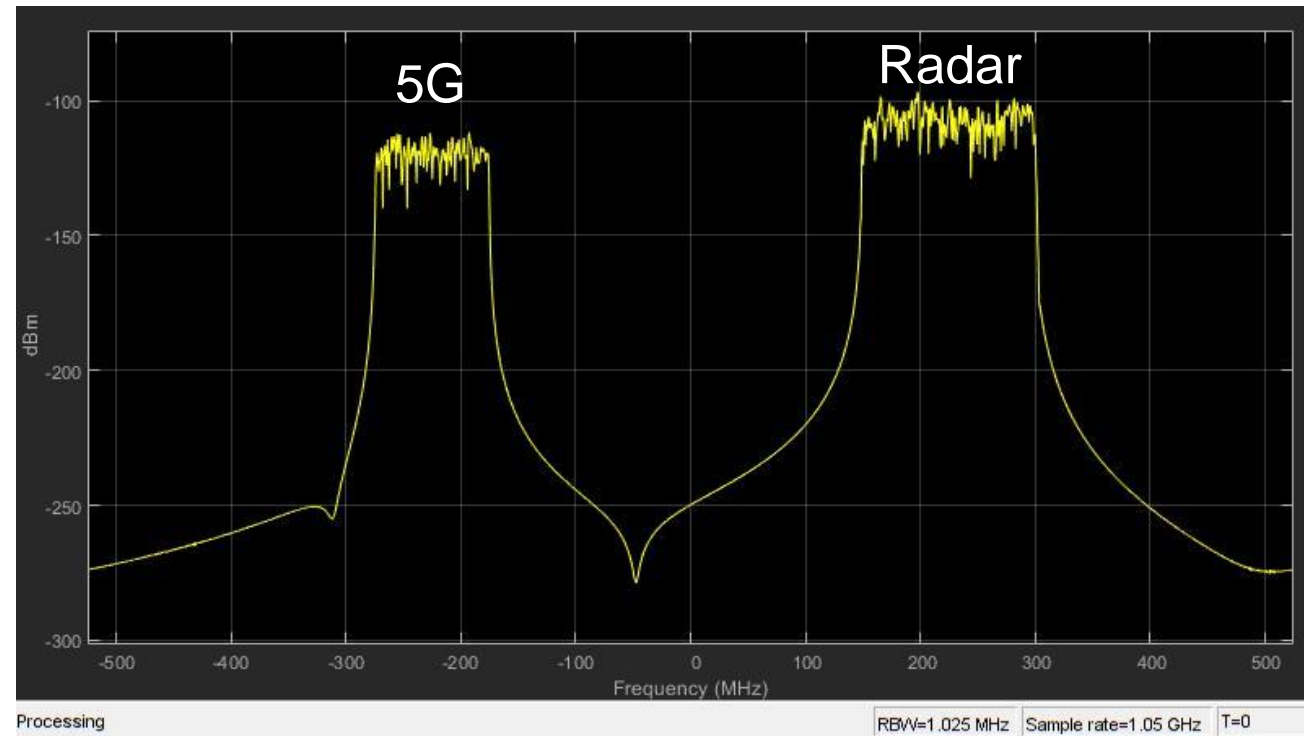
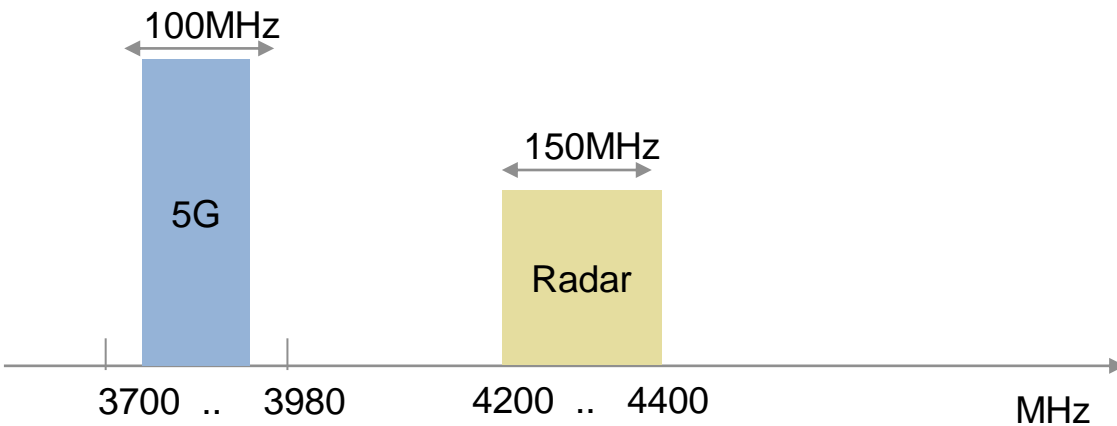
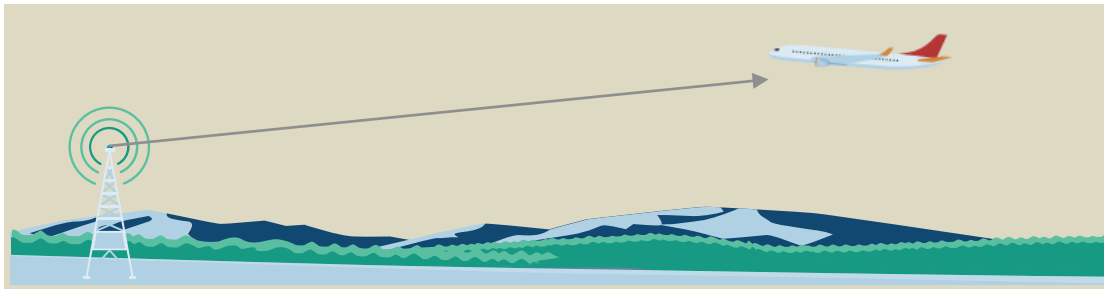
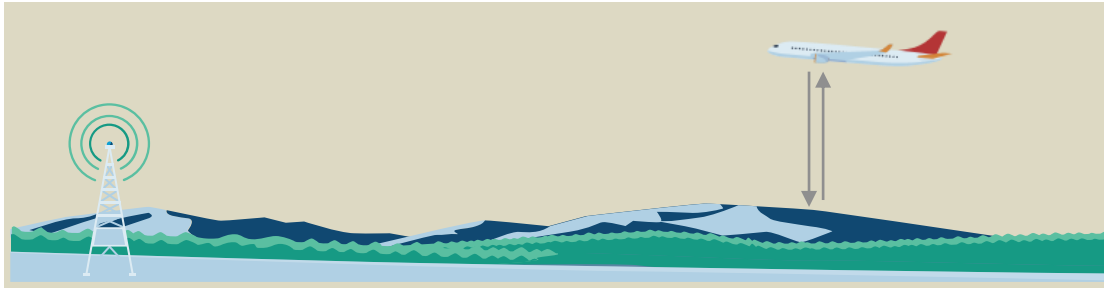

Processing RBW=1.025 MHz Sample rate=1.05 GHz T=0

Simulate the interference from fundamental emissions of 5G

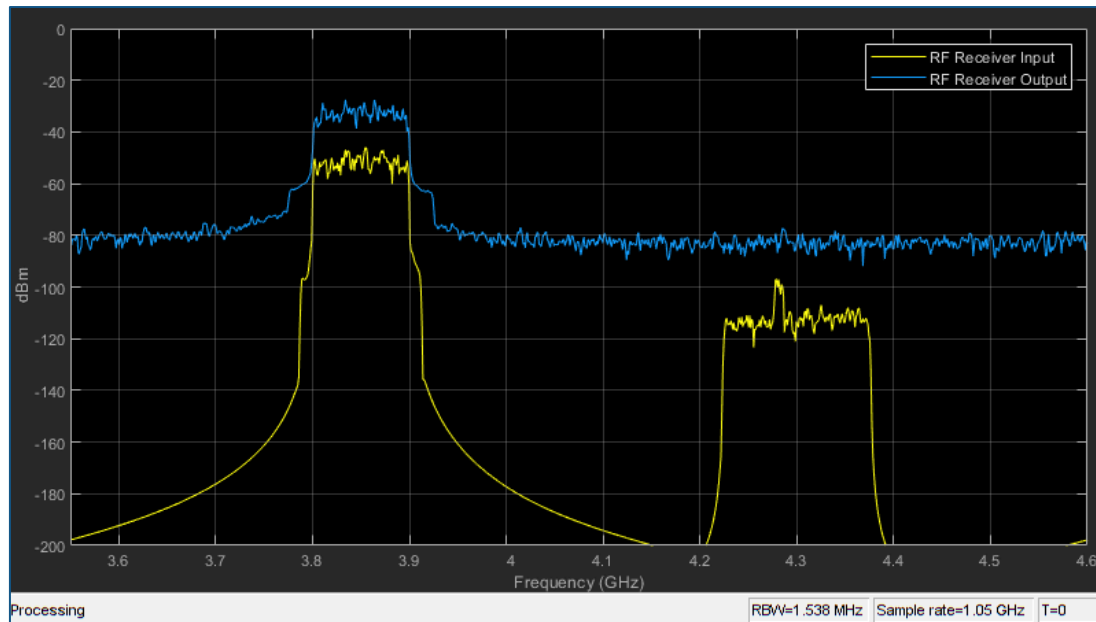
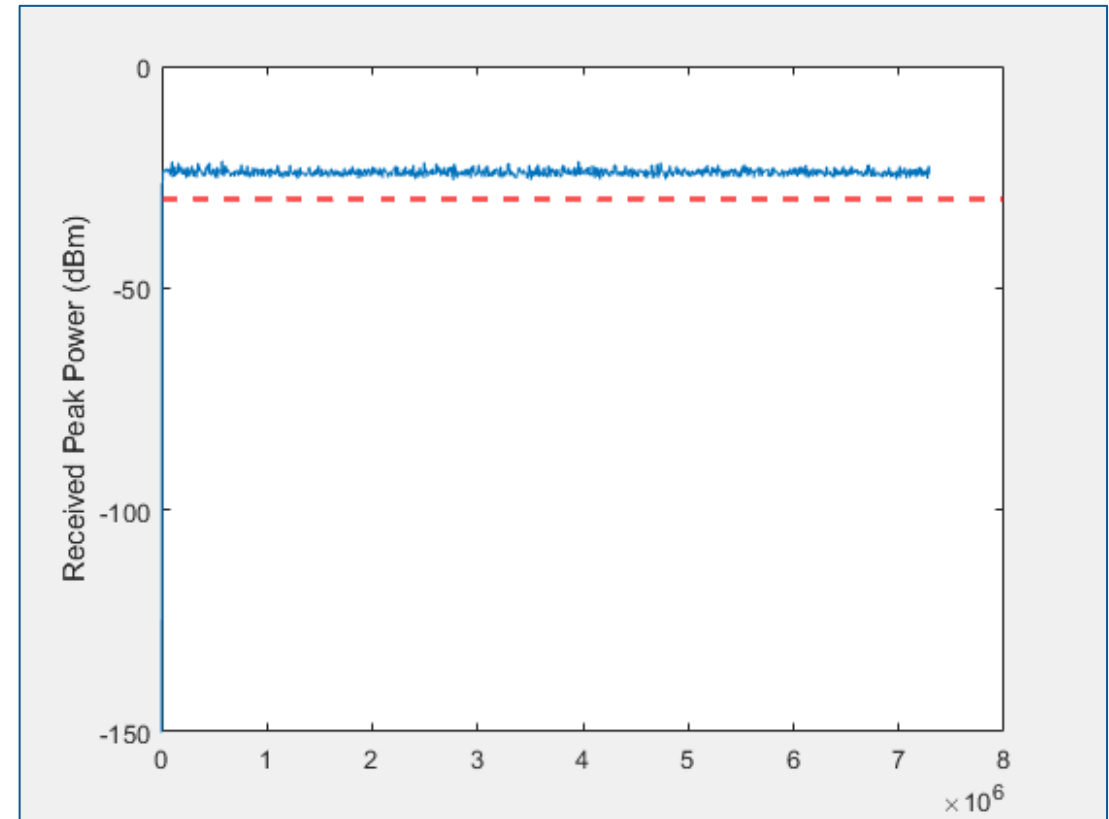
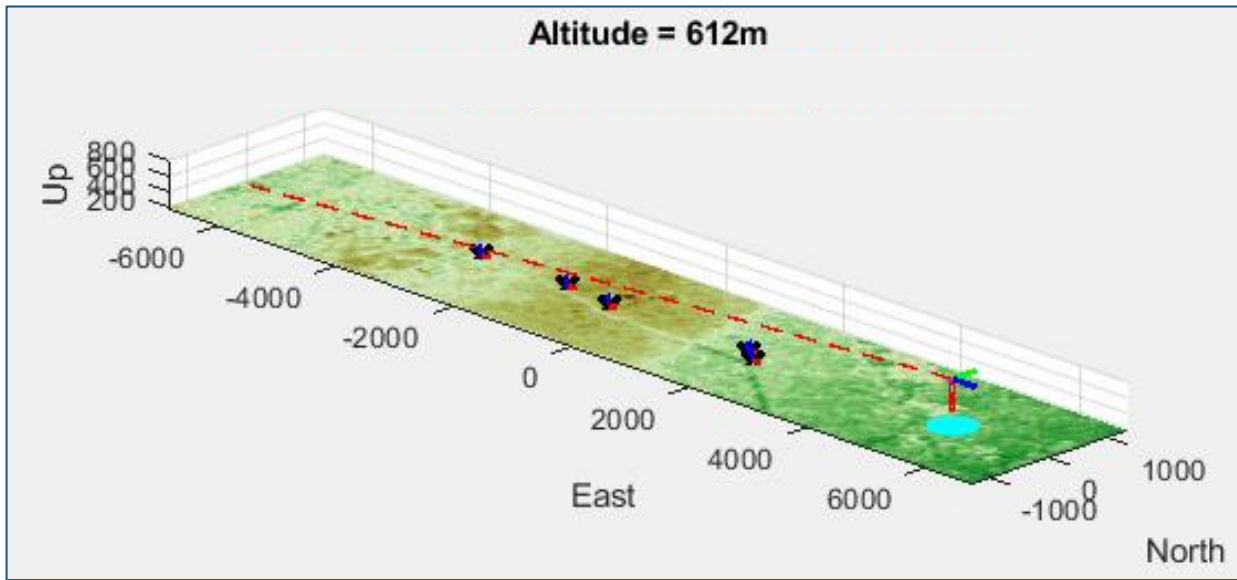

Analyze and Simulate in the RF Domain

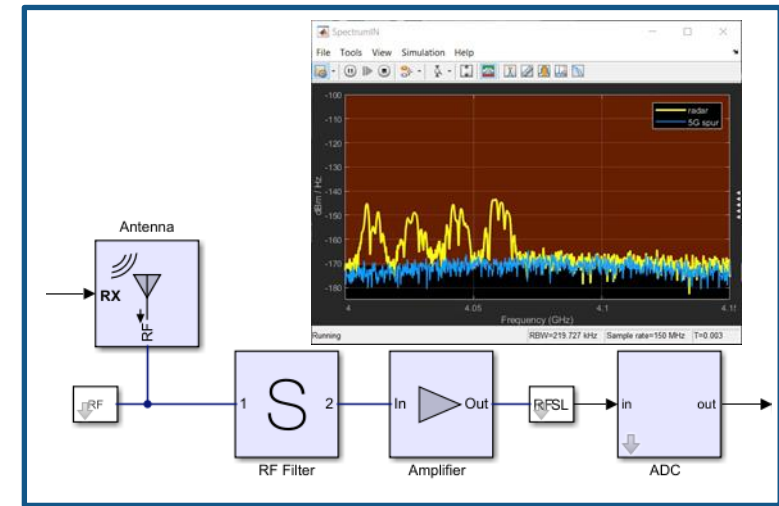

Two Problems to Analyze and Simulate in the RF Domain

Problem #1: 3GPP fundamental emissions

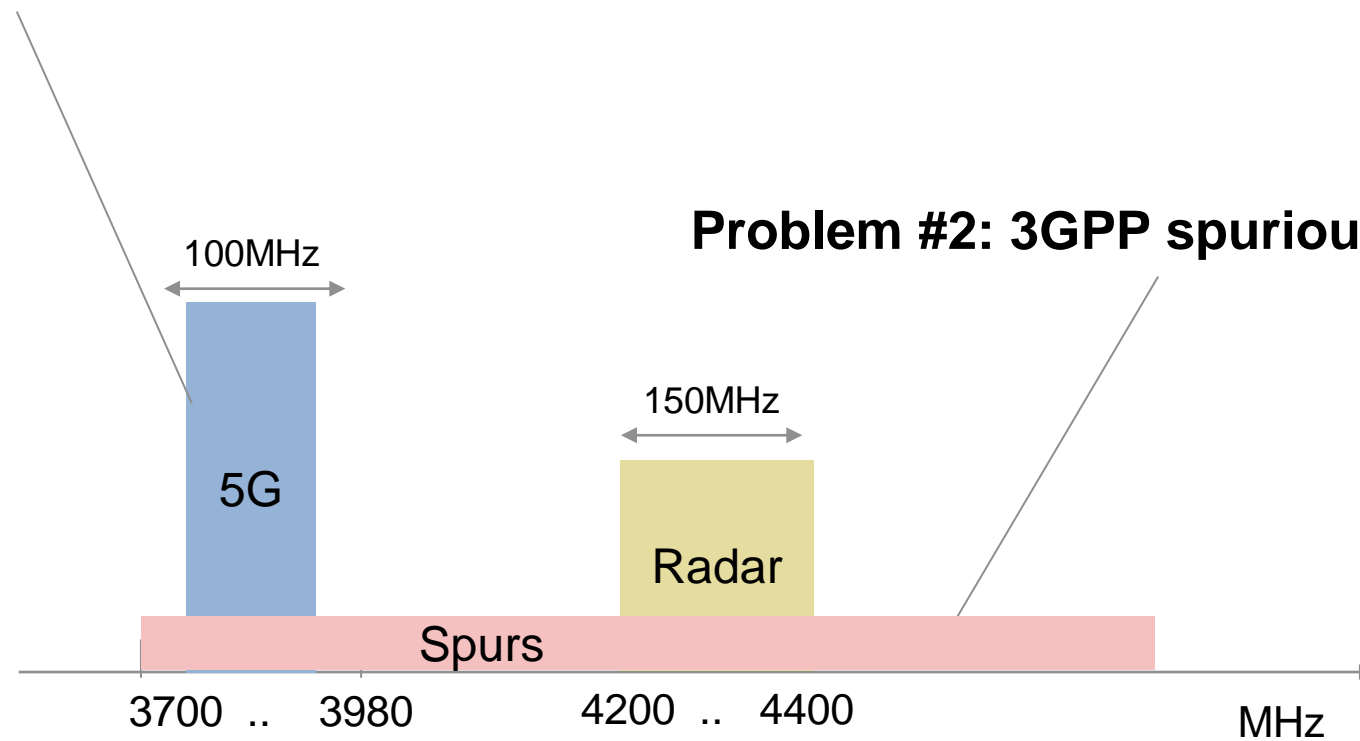

Problem #1: 3GPP Fundamental Emissions

Saturation and spectral regrowth

5G TX power

5G center frequency

Noise floor

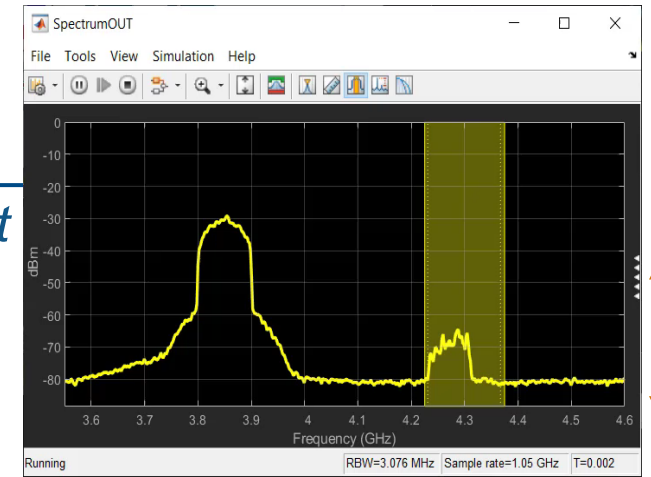
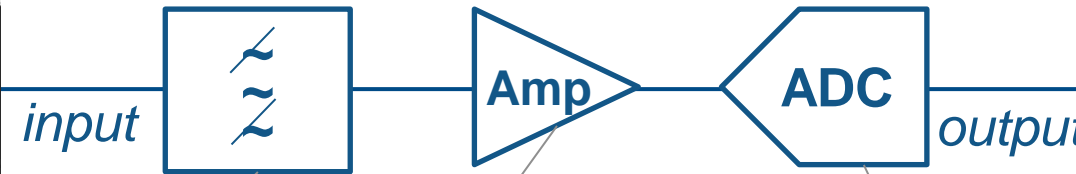
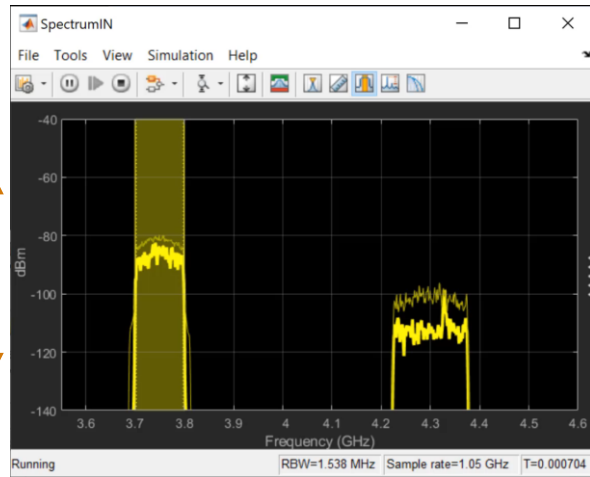

Amplifier

- Gain
- Noise figure
- Non-linearity (IP3)
- **Saturation (P1dB/Psat)**

ADC

- Quantization noise
- **Saturation**
- **Dynamic range**

Input filter

- **S-parameters selectivity**

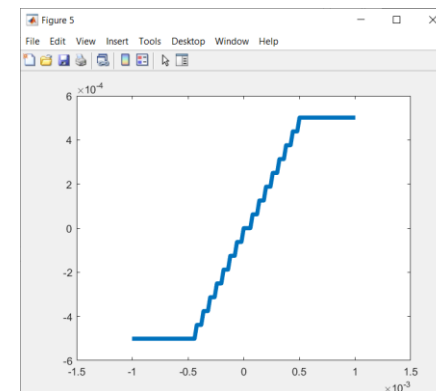
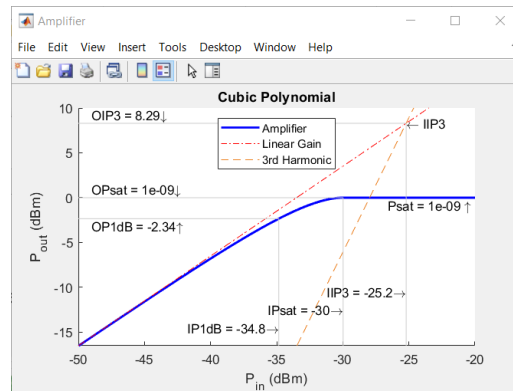
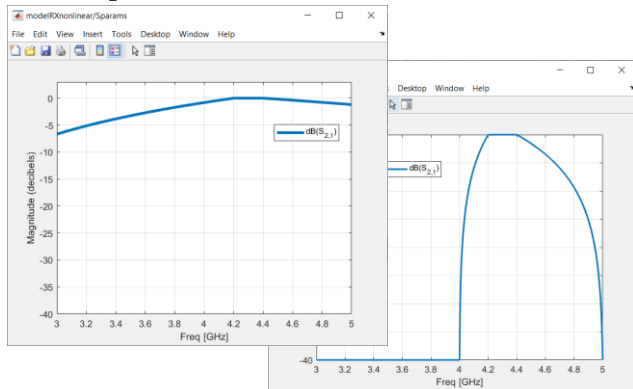

Can 3GPP Fundamental Emissions Cause Front-End Overload?

It depends ...

- Location of the base station and flight path
- 5G beam direction and transmitted power
- Receiver filter selectivity and saturation power

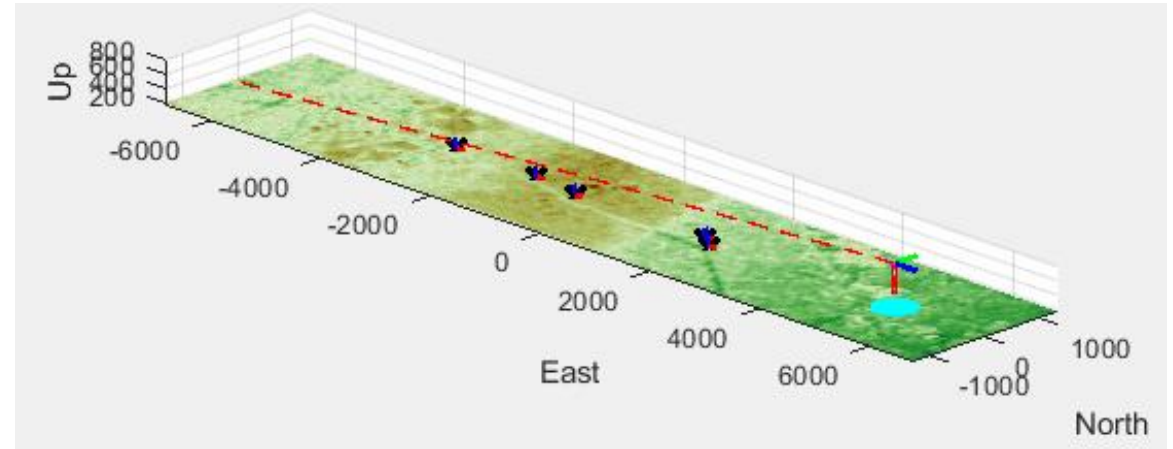

Simulate the (worst-case) scenario and verify the altitude reading!

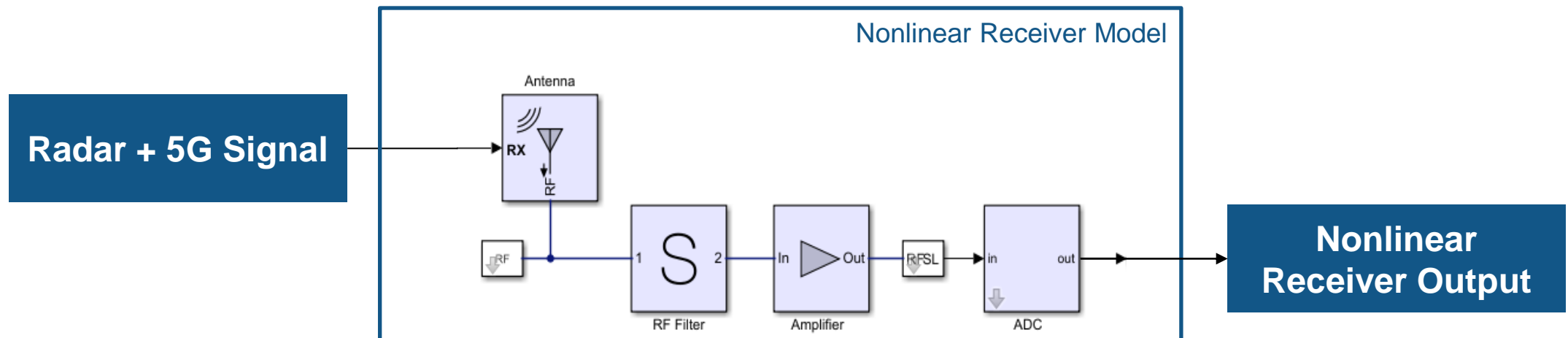

Simulation of Worst-Case Scenario: Erroneous Altitude Reading

- 5G Base station
 - TX power = 67.5dBm
 - Antenna steered towards airport
- Altimeter receiver
 - RF filter attenuation \sim 3dB
 - Input referred saturation power \sim -30dBm
- Possible mitigation strategies
 - Increase RF filter attenuation: \sim -40dB
 - Increase receiver saturation: -10dBm
 - Change signal processing algorithm

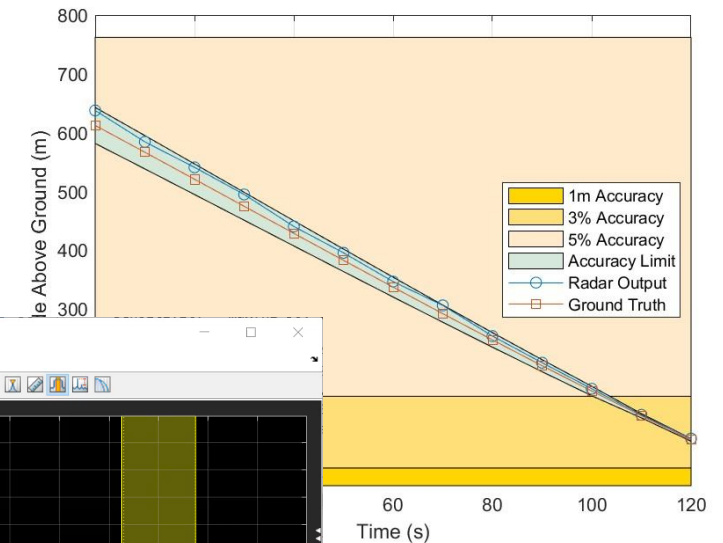
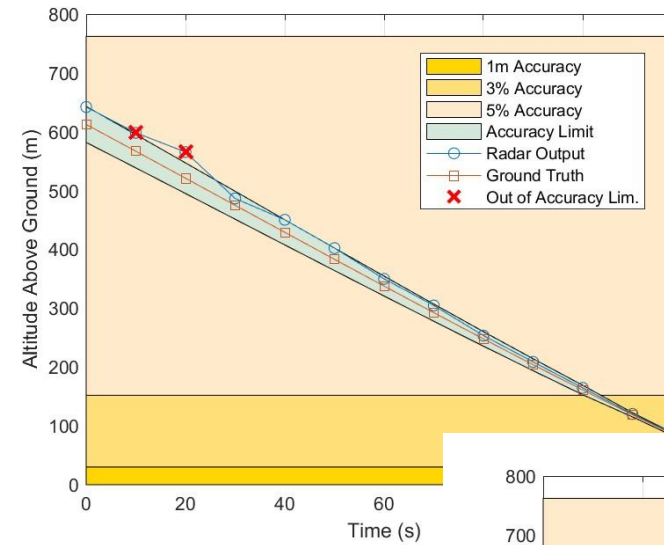

Problem #2: 3GPP Spur Emissions

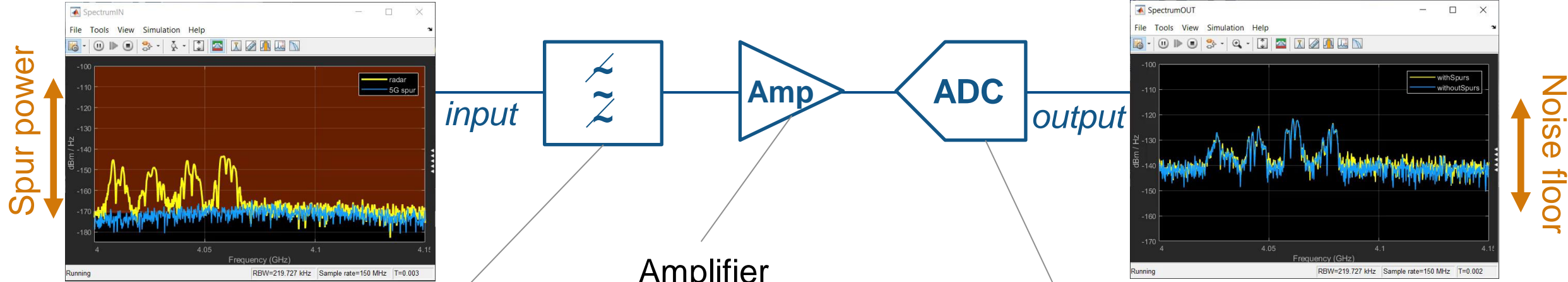

Spur power

Noise floor

In-band spurs

Input filter

- S-parameters selectivity

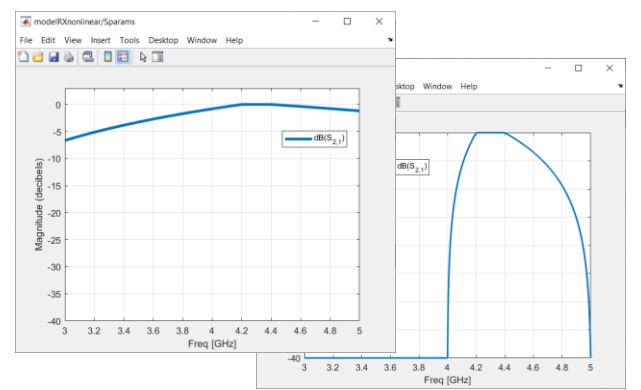

Amplifier

- Gain
- **Noise figure**
- Non-linearity (IP3)
- Saturation

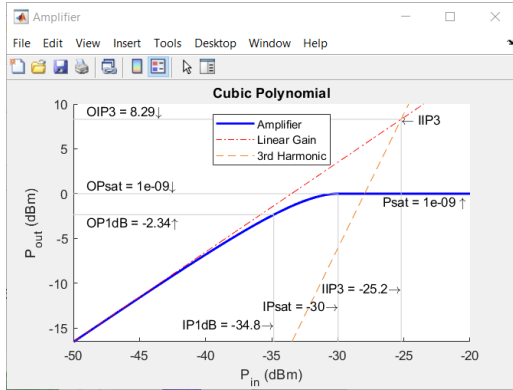

ADC

- **Quantization noise**
- Saturation
- Dynamic range

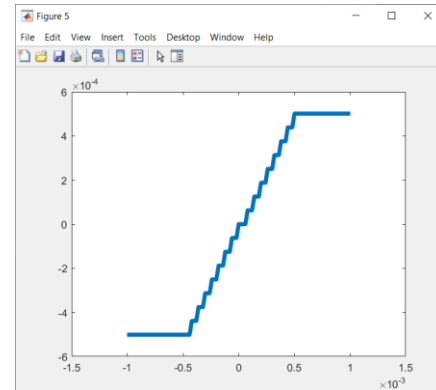

Can 3GPP Spur Emissions Cause Receiver Desensitization?

Desensitization = increase of the receiver noise floor by 1dB due to spur emissions

- Model the base station worst-case scenario and compare with regulations
 - TX power = -13.6dBm/MHz
 - Antenna steered towards airport
- Simulate spurious signals and measure noise floor / SNR!

NF = 8dB and BW = 150MHz

Noise floor = $-174\text{dBm/Hz} + 10 \cdot \log_{10}(\text{BW}) + \text{NF}$
 = -84dBm or -166dBm/Hz

Regulation: Spur < Noise floor - 6dB = -172dBm/Hz

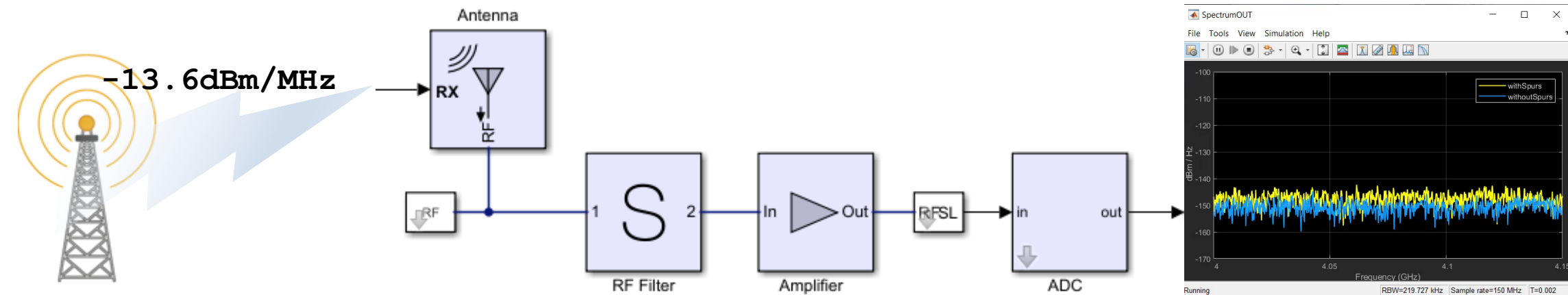

In summary, you can analyze the effects of interference between radar and wireless systems with modeling and simulation



Increasing Congestion in the RF Spectrum

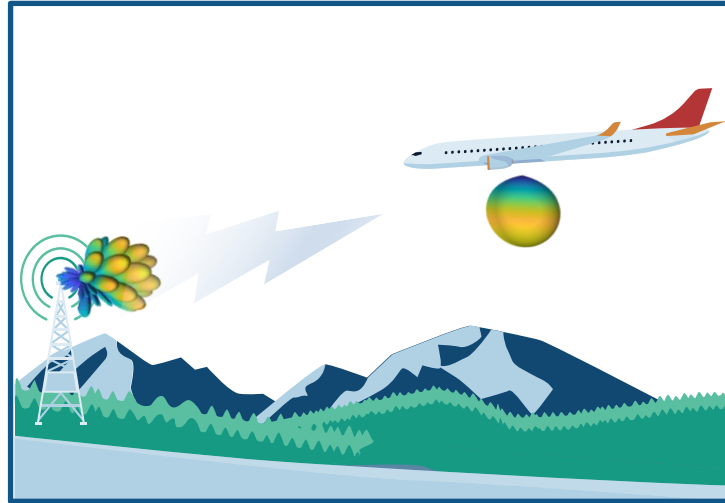

Scenario Modeling for Radar and Wireless Coexistence

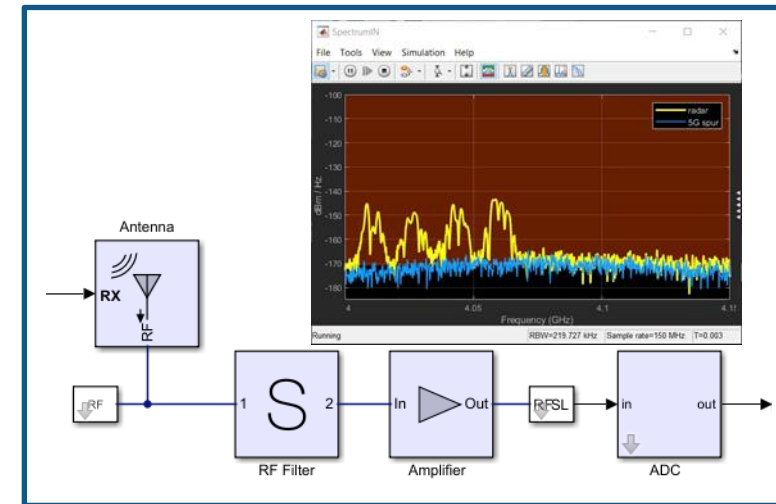

Analyze and Simulate in the RF Domain

MATLAB EXPO

Thank you



© 2022 The MathWorks, Inc. MATLAB and Simulink are registered trademarks of The MathWorks, Inc. See [mathworks.com/trademarks](https://www.mathworks.com/trademarks) for a list of additional trademarks. Other product or brand names may be trademarks or registered trademarks of their respective holders.