

WHITE PAPER

# Exploring Hybrid Beamforming Architectures for 5G Systems

This white paper demonstrates how you can use MATLAB® and Simulink® to:

1. Design MIMO phased arrays, including complex subarray structures
2. Partition hybrid beamforming systems intelligently across RF and baseband domains
3. Model multiple-input multiple-output (MIMO) wireless communication systems
4. Explore architectural choices and tradeoffs
5. Evaluate the quality of the partitioning design choices you make

## Background

5G New Radio (NR) wireless communication systems use MIMO beamforming technology for signal-to-noise ratio (SNR) enhancement and spatial multiplexing to improve the data throughput in scatterer-rich environments. In a scatterer-rich environment, line-of-sight (LOS) paths between the transmit and receive antennas are not always present.

To gain the required throughput, MIMO beamforming implements precoding on the transmitter side and combining on the receiver side to increase SNR and to separate spatial channels. A full digital beamforming structure requires each antenna to have a dedicated RF-to-baseband chain, which can increase the overall hardware cost and drive the power consumption higher.

As a solution, hybrid beamforming is used to employ fewer RF-to-baseband chains. With deliberate selection of the weights for precoding and combining, hybrid beamforming can achieve a level of performance that is comparable to that of full (all-digital) beamforming.

System modeling can be realized using baseband equivalent models to start. These types of models can be developed quickly and they provide the fastest simulation speed options. Building blocks are available to design wireless subsystems. These subsystems can be integrated to form a physical layer simulation. The resulting model can be used to drive beamforming partitioning decisions between the RF and digital domains.

To help navigate the path to multidomain (RF and baseband) modeling, you can use a baseband Simulink model with hybrid MIMO beamforming to help start your system-level design. A framework is described in this white paper that includes two example hybrid beamforming algorithms: quantized sparse hybrid beamforming (QSHB) and hybrid beamforming with peak search (HBPS). The APIs into the model are open so that you can also integrate your own custom algorithms for hybrid beamforming.

The Simulink baseband model also provides a starting point to move to the multidomain model with RF components using RF Blockset.

In this white paper, Phased Array System Toolbox™, RF Blockset™, Communications Toolbox™, and 5G Toolbox™ are used in the associated workflows.

## Hybrid Beamforming Architecture

Figure 1 shows a block diagram of a hybrid beamforming system with a transmitter, a channel, and a receiver.

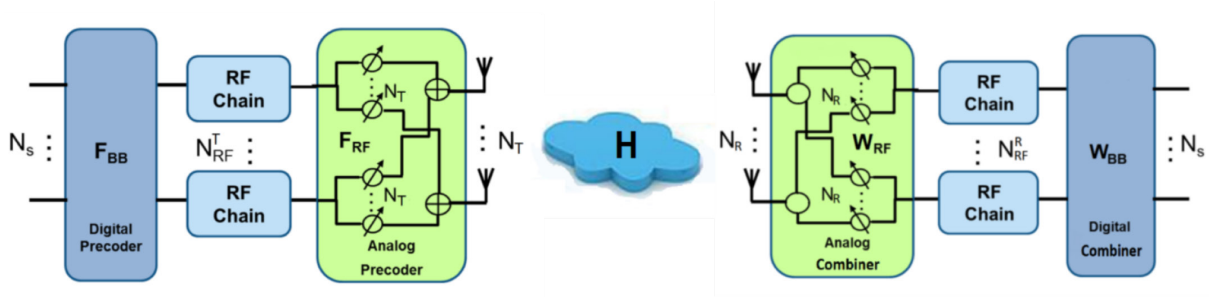

Figure 1. Hybrid beamforming system structure: transmitter, channel, and receiver.

The parameters shown in Figure 1 are defined as follows:

$F_{RF}$ Analog precoder of size $N_T \times N_{RF}^T$	$N_T$ Number of Tx antennas
$F_{BB}$ Digital precoder of size $N_{RF}^T \times N_s$	$N_R$ Number of Rx antennas
$W_{RF}$ Analog combiner of size $N_R \times N_{RF}^R$	$N_s$ Number of signal streams
$W_{BB}$ Digital combiner of size $N_{RF}^R \times N_s$	$N_{RF}^T$ Number of Tx RF chains
$H$ MIMO channel matrix of size $N_R \times N_T$	$N_{RF}^R$ Number of Rx RF chains

In the framework described below, you can explore different combinations of values for the parameters shown in Figure 1. Specifically, the number of antennas and the number of RF chains can be evaluated. The number of RF chains is important because this is where hardware cost savings can be achieved. By “sharing” the digital weights across multiple RF channels, less hardware is needed. The challenge is reducing hardware without impacting system performance.

## Building the Model

Using a Simulink model of a massive MIMO system, hybrid beamforming algorithms can be developed and tested before system implementation. You can also generate both the RF phase shifts and digital weights directly for each configuration. While the system described here is based on QSHB and HBPS, you can also extend this model to custom algorithms that you develop.

The model of the system consists of the following four major components, as shown in Figure 2:

- MIMO transmitter
- MIMO channel
- MIMO receiver
- Hybrid weight calculation

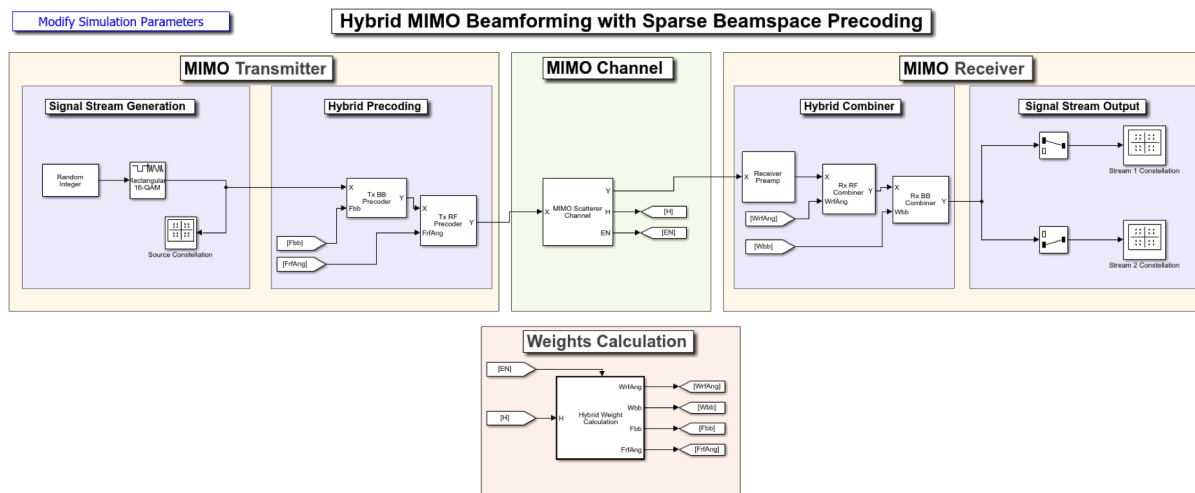

Figure 2. Simulink model of a hybrid beamforming system.

For this workflow, you can integrate a specific MIMO channel matrix  $H$ . The matrix  $H$  can be estimated in the transmitter or receiver, depending on the time or frequency division duplexing (TDD or FDD) modes used.

The structures of the transmitter, receiver, and MIMO channel blocks are independent from the precoding and weight matrix generation. The QSHB and HBPS algorithms are implemented in the Weight Calculation block of the model and can be viewed or customized for your system.

The generated MIMO channel matrix  $H$  is invariant to the number of transmitted symbols, so the precoding and combiner matrices will be the same for all of the symbols.

The MIMO transmitter generates the signal stream and then applies the precoding to leverage spatial multiplexing. The modulated signal is propagated through a scattering channel defined in the MIMO channel and then decoded and demodulated at the receiver side.

## Why Spatial Multiplexing?

The challenge in 5G systems goes beyond SNR. To achieve higher channel capacity, the system has to operate in multipath fading environments, beyond simple line-of-sight paths.

The concept behind spatial multiplexing is that a MIMO system, within a multipath channel and a rich scatterer environment, can send multiple data streams simultaneously across the channel. The goal of spatial multiplexing is less about increasing the SNR and more about increasing the information throughput.

With spatial multiplexing, the channel matrix is separated into multiple modes so that data streams sent from different elements in the transmit array can be independently recovered from the received signal. To achieve this result, each data stream is precoded before the transmission and then combined and recovered after the reception. The information collected by each receiver element is simply a scaled version of the signal at each transmit array element, which means it behaves like multiple orthogonal subchannels within the original channel. The first subchannel corresponds to the dominant transmit and receive directions but signal processing techniques can be used to equalize the subchannels. In addition, it is possible to use other subchannels to carry information. Intelligence can be applied to the allocated power per element; industry research is still very much active in this area.

With this backdrop, the next question is, how do your array design choices impact your system-level performance? The answer really depends on the nature of the channel. That is, arrays can be used to either improve the SNR via the array gain, or the diversity gain, or improve the capacity via the spatial multiplexing.

Figure 3 illustrates an abstracted view of a multiscatterer channel. Also in Figure 3, you can see the throughput for a single LOS data stream compared with that of multiple data streams (two in this case) in a multipath environment. Note that while the second stream doesn't provide a gain as high as the first stream (because it uses a less dominant subchannel), the overall information throughput is improved. Again, equalization techniques can be applied to improve the non-dominant channels. In addition, this concept can easily extend to many more channels.

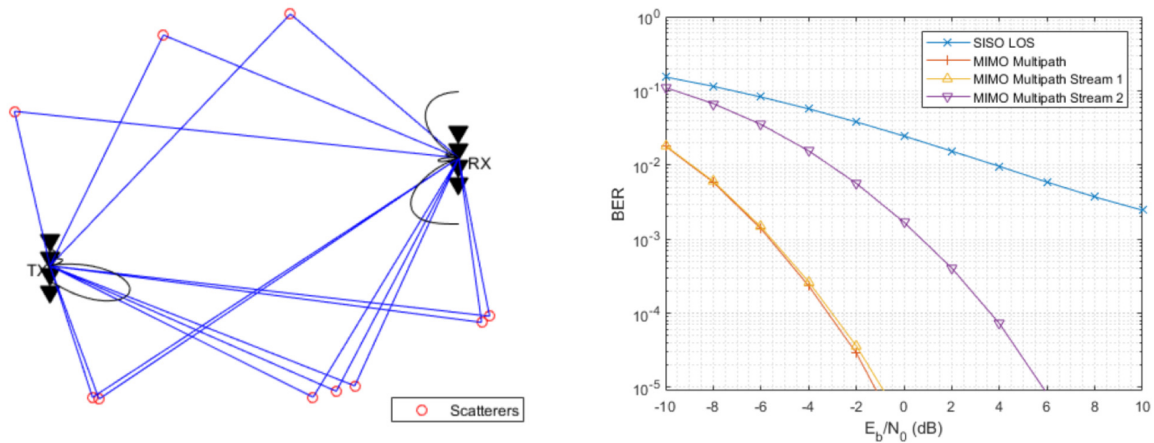

Figure 3: Multiscatterer scenario (left) and BER improvements in multipath scenarios vs. LOS (right).

## MIMO Transmitter and Receiver

For the transmitter and receiver subsystems, the focus of the engineering tradeoff is cost vs. performance. This in turn drives partitioning of the beamforming architecture between the RF and baseband domains. Partitioning in turn brings us to the topic of subarrays, where multiple antenna elements are mapped to specific RF channels. Subarrays are integrated to build up a full antenna array. Sometimes element feeds are shared across subarrays to create virtual arrays. In this scenario, the total number of transmit/receive modules is less than the number of antenna elements for each subarray, which results in less hardware in large systems.

Having less hardware is an advantage from a cost and power perspective, but without an all-digital beamforming design, some flexibility is sacrificed in the RF portion of the beam steering. This occurs when the same RF phase shift value is applied to each channel of a subarray. It contrasts with the all-digital case, where phase and amplitude weighting can be unique values for each channel.

In the example for this white paper, two signal streams are generated. The transmitter system consists of 64 transmit antennas with four transmit RF chains. There are 16 receive antennas that feed four receive RF chains. Both arrays are shown in Figure 4.

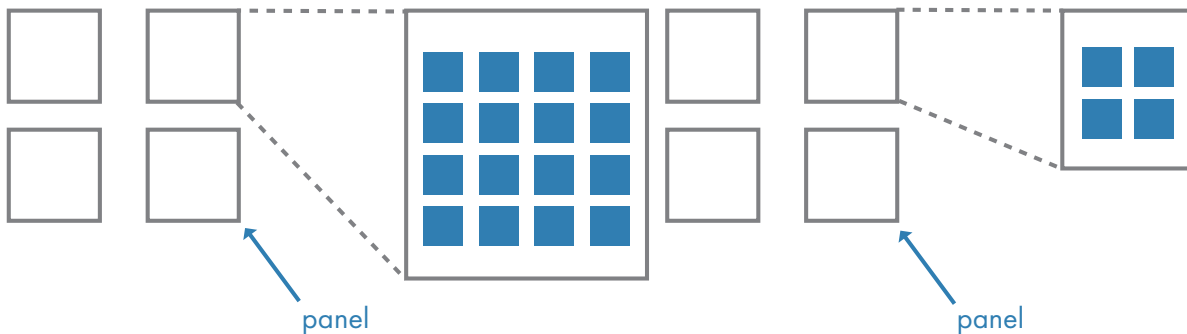

Figure 4. 64-element transmit array with four RF chains (left), and 16-element receive array with four RF chains (right).

Along with the partitioning, it is desirable to maximize the spectral efficiency to improve channel capacity. One way this could be accomplished is to require that each RF chain be used to send an independent data stream. Assuming the channel is known, the unconstrained optimal precoding weights can be obtained by diagonalizing the channel matrix and extracting the dominate modes.

## Waveform Generation

A range of modulation schemes can be used, including 5G uplink and downlink waveforms. To illustrate an example of waveform building blocks, consider a 5G New Radio (NR) downlink waveform, which is part of 5G Toolbox. The number of parameters that can be defined is extensive and covers the synchronization signal definition, the carrier configuration, and the control resource set.

To start, the parameterization and generation of multiple bandwidth parts (BWPs) is required. A BWP is formed by a set of contiguous resources sharing a numerology on a given carrier. Each BWP can have different subcarrier spacings (SCSs), use different cyclic prefix (CP) lengths, and span different bandwidths, and different BWPs can overlap with each other.

With all of the parameters set in the carrier configuration, a waveform is generated directly.

Figure 5 shows an example waveform as a function of subcarriers and symbols.

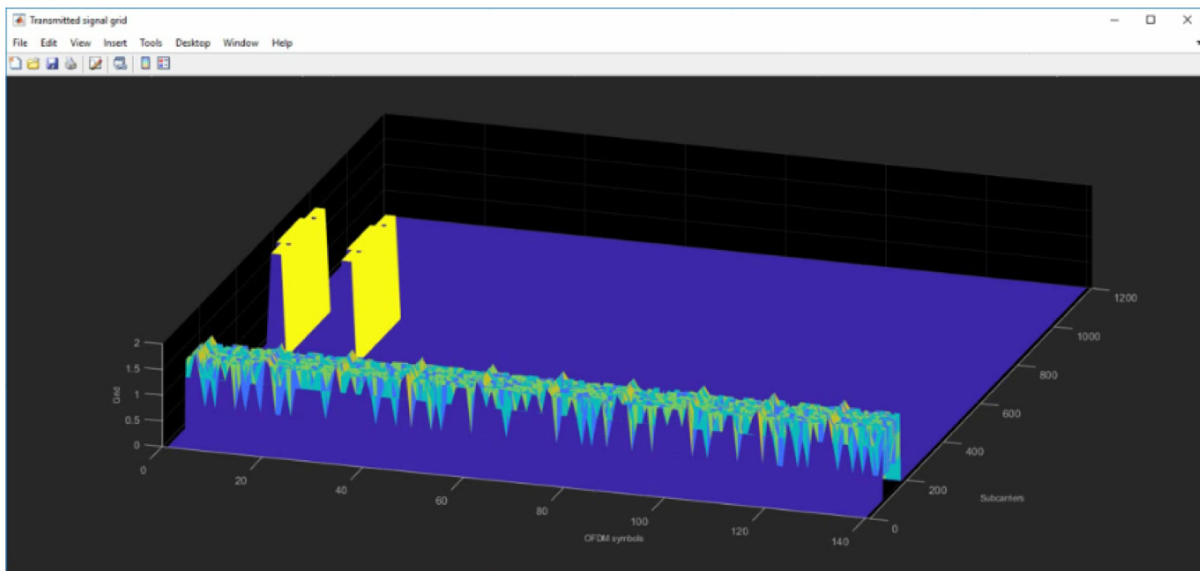

Figure 5. 5G New Radio (NR) downlink waveform.

A structure in MATLAB with the information corresponding to an example BWP is shown below.

**Information associated to BWP 1:**

```

SamplingRate: 61440000
      Nfft: 4096
      Windowing: 10
CyclicPrefixLengths: [1x14 double]
      SymbolLengths: [1x14 double]
      NSubcarriers: 2400
SubcarrierSpacing: 15
      SymbolsPerSlot: 14
      SlotsPerSubframe: 1
SymbolsPerSubframe: 14
SamplesPerSubframe: 61440
SubframePeriod: 1.0000e-03
      Midpoints: [1x141 double]
WindowOverlap: [10 10 10 10 10 10 10 10 10 10 10 10 10 10]

```

To simplify the model, a basic 16 QAM modulation scheme is implemented for the example in this white paper. The constellation diagram for this modulation scheme is shown in Figure 6.

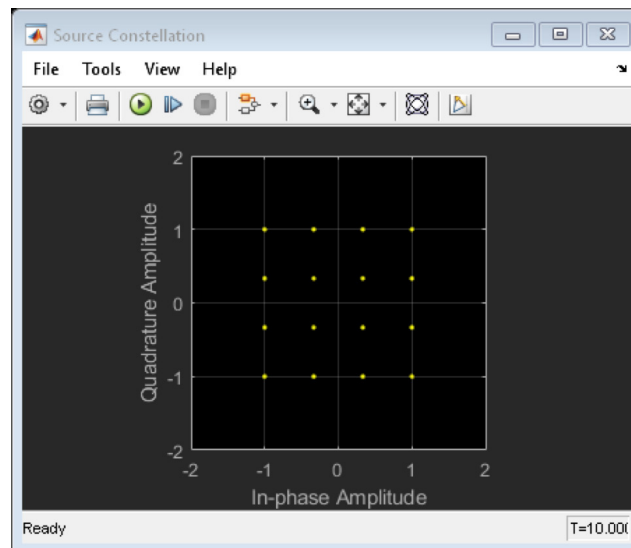

Figure 6. Constellation diagram of QAM16 modulation.



## Hybrid Beamforming Weights Computation

In a hybrid beamforming system, both the precoding and the corresponding combining process are performed across baseband and RF. In general, the beamforming achieved in RF involves phase shifts. Therefore, a critical component of the workflow is to determine how to distribute the weights between the baseband and the RF band based on the channel.

This is done in the Weight Calculation block (refer back to Figure 2), where the precoding weights,  $F_{bb}$  and  $F_{rfAng}$ , and combining weights,  $W_{bb}$  and  $W_{rfAng}$ , are computed based on the channel matrix,  $H$ . Figure 7 provides a view of the block parameters that are used to compute the both the precoding and combining weights for the MIMO channel. These can be configured directly to explore other system combinations.

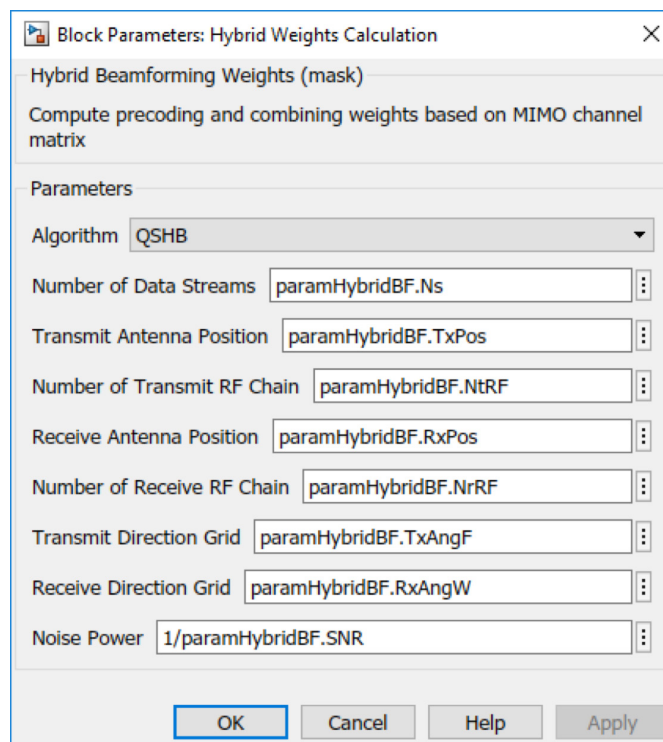

Figure 7. Hybrid weight mask to compute precoding and combining weights based on a MIMO channel matrix.

## Quantized Sparse Hybrid Beamforming

Given the channel matrix,  $H$ , of a MIMO scattering channel, the hybrid beamforming weights can be computed.

Using an orthogonal matching pursuit algorithm, the resulting analog precoding and combining weights are just steering vectors corresponding to the dominant modes of the channel matrix.

The QSHB algorithm produces the following information:

1. Precoding matrices  $F_{RF}$  and  $F_{BB}$
2. Combining matrices  $W_{RF}$  and  $W_{BB}$

Having the resolved hybrid beamforming matrices, the estimates  $\hat{\mathbf{s}}$  of the  $N_s$  signal streams can be represented as:

$$\hat{\mathbf{s}} = \sqrt{\rho} W_{BB}^* W_{RF}^* H F_{RF} F_{BB} \mathbf{s} + W_{BB}^* W_{RF}^* \mathbf{n}$$

where  $\mathbf{s}$  is the signal stream of dimension  $N_s$  and  $\mathbf{n}$  is the channel noise vector of dimension  $N_R$ .

## Quantized Sparse Hybrid Beamforming with Peak Search

HBPS is a simplified version of QSHB. Instead of searching for the dominant mode of the channel matrix iteratively, HBPS projects all the digital weights into a grid of directions and identifies the  $N_{RF}^T$  and  $N_{RF}^R$  peaks to form the corresponding analog beamforming weights. This works well, especially for large arrays, like the ones used in massive MIMO systems. This is because for large arrays, the directions are more likely to be orthogonal.

Because the channel matrix can change over time, the weights computation also needs to be performed periodically to accommodate the channel variation.

## QSHB

You can recover the 16 QAM symbol streams at the receiver using the QSHB algorithm. The resulting constellation diagram (Figure 8) shows that compared with the source constellation, the recovered symbols are properly located in both streams. This demonstrates that by using the hybrid beamforming technique, you can improve the system capacity by sending the two streams simultaneously. In addition, the constellation diagram shows that the variance of the first recovered stream is better than that of the second recovered stream as the points are less dispersed. This is because the first stream uses the most dominant mode of the MIMO channel, so it has the best SNR.

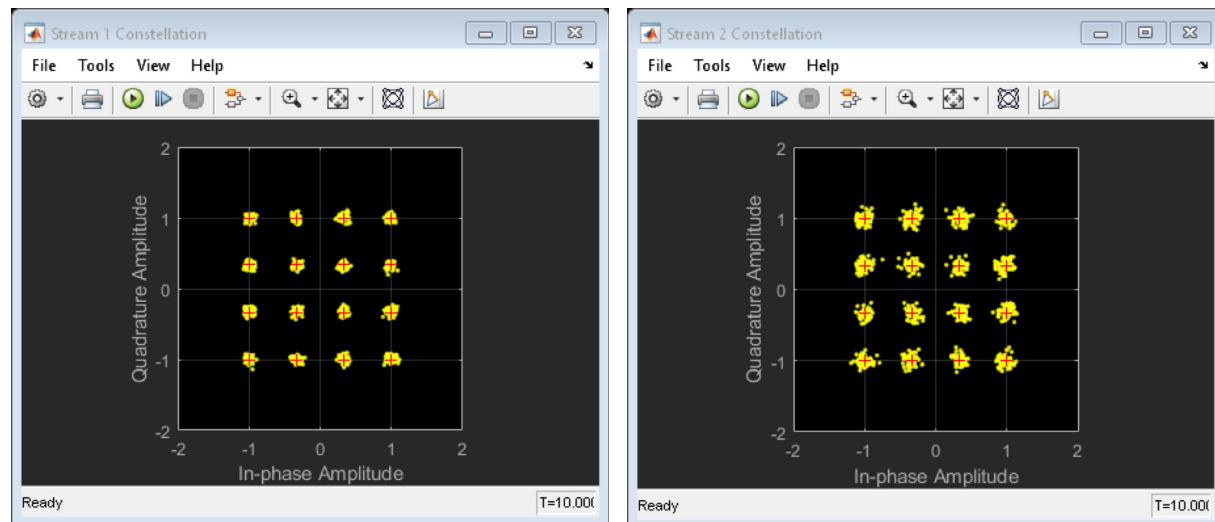

Figure 8. Stream 1 and 2 constellation diagram for QSHB.

## HBPS

The result of HBPS is shown in Figure 9. The constellation diagram shows that it achieves similar performance compared with QSHB. This means that the HBPS is a good choice for the simulated 64x16 MIMO system.

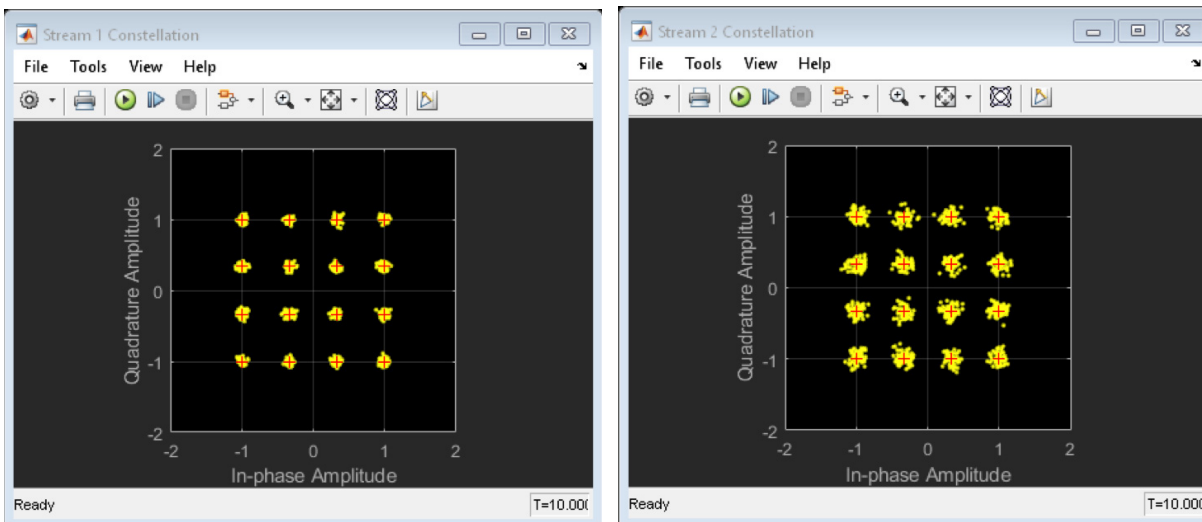

Figure 9. Stream 1 and 2 constellation diagram for HBPS.

## Spectral Efficiency Comparison of Algorithms

There are multiple methods for measuring the effectiveness of the partitioning. Spectral efficiency is commonly used as a MIMO system performance metric. You can compare the spectral efficiency achieved using the optimal weights (all-digital weights) with that using the proposed hybrid beamforming algorithms, QSHB and PSHB.

For ease of understanding, the simulation uses one- and two-signal streams, but this can also be extended to match your system. The transmitter antenna array can also be defined to match your system requirements.

For this system, the array pattern covers 80 degrees in azimuth and 40 degrees in elevation, and the receiver antenna covers 120 degrees in azimuth and 80 degrees in elevation. The resulting spectral efficiency curves are obtained from 50 Monte Carlo trials for each SNR value. In the plots in Figure 10, the spectral efficiency of QSHB is about 1dB off from the optimal full digital beamforming.

While the PSHB algorithm provides better computational efficiency, an additional loss of up to 1.5 dB in spectral efficiency occurs compared to the QSHB.

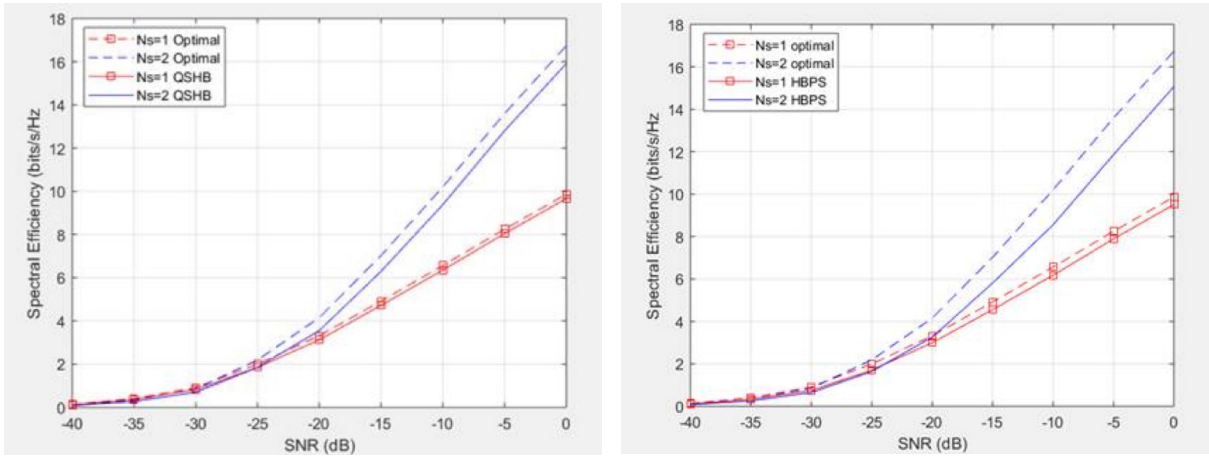

Figure 10. Efficiency comparison of QSHB (left) and PSB (right).

### Comparing Other Partitioning Options

The system parameters are given in the System Setup section of the Simulink model shown in Figure 2. The values for  $N_t$ ,  $N_{tRF}$ ,  $N_r$ , and  $N_{rRF}$  control the partitioning in this example. Figure 11 shows the constellation diagrams with different combinations of these system parameters.

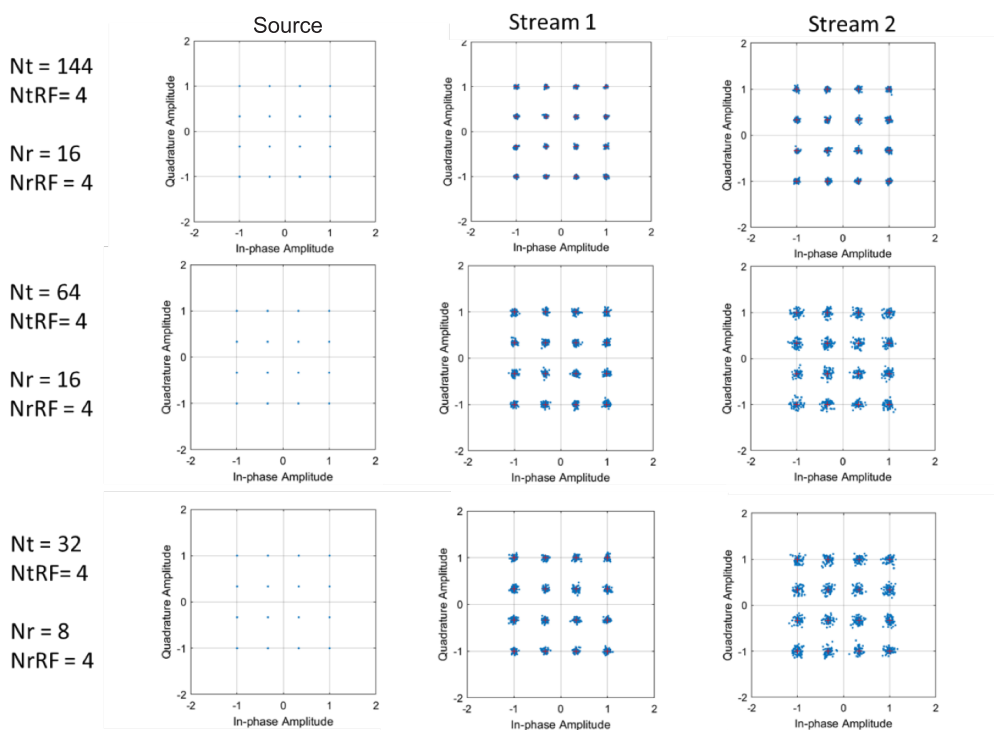

Figure 11. System configurations and corresponding constellation diagrams for using different partitioning options.

## Extending the Fidelity: Integrating RF Blockset

With a Simulink model of the hybrid beamforming system in place, you can move to higher levels of fidelity. This is where RF Blockset can be used directly to create a multidomain simulation of the system. Nonlinear RF amplifiers and model effects can be used to estimate gain, noise, even-order, and odd-order intermodulation distortion. RF models can be characterized using data sheet specifications or measured data, and can be used to accurately simulate adaptive architectures, including automatic gain control (AGC) and digital predistortion (DPD) algorithms.

With RF Blockset you can model RF systems at different levels of abstraction. Circuit envelope simulation enables high-fidelity, multicarrier simulation of networks with arbitrary topologies. The Equivalent Baseband library enables fast, discrete-time simulation of single-carrier cascaded systems. Figure 12 shows an example of a hybrid system with a partitioned system. Here, baseband weighting is applied to the digital streams that feed each transmit/receive module. The remaining weights are applied as phase shifts to the RF channels feeding the antenna elements.

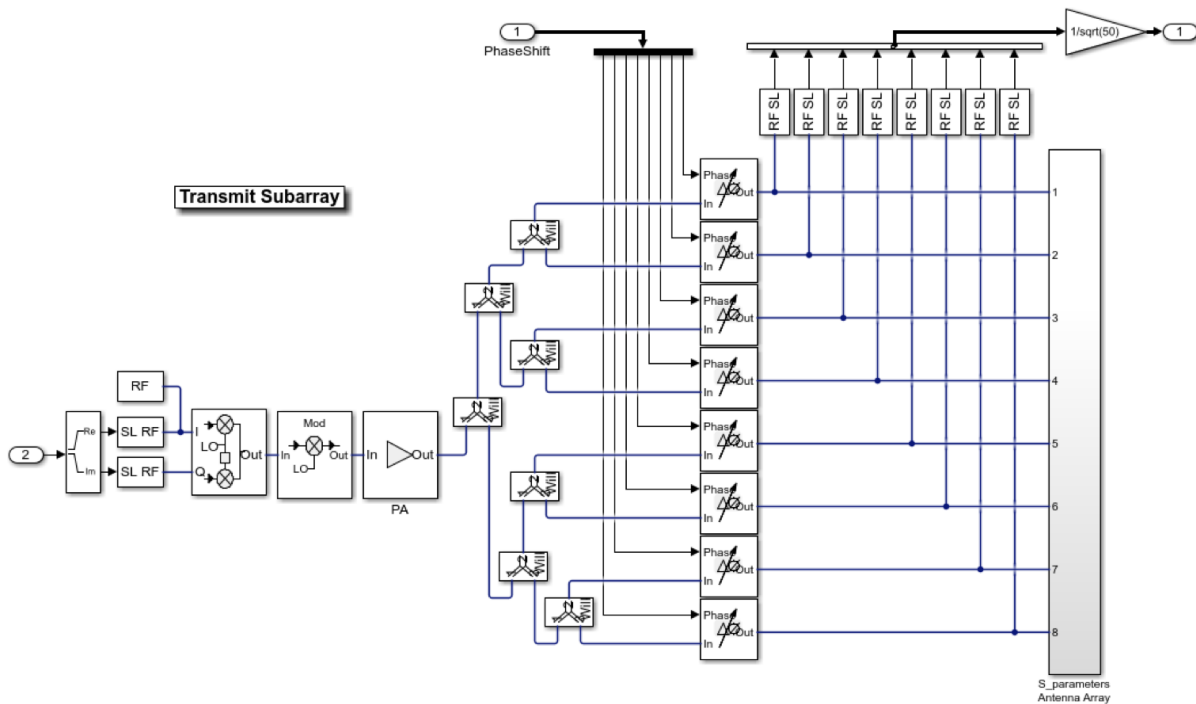

Figure 12. Example of RF Blockset hybrid structure with baseband and RF weighting.

## Summary

Using MATLAB and Simulink, you can design antenna, RF, and signal processing systems in single environment. Modeling can help to define architectures for hybrid beamforming. You can:

- Design MIMO phased arrays, including complex subarray structures
- Partition hybrid beamforming systems intelligently across RF and baseband domains
- Model MIMO wireless communication systems
- Explore architectural choices and tradeoffs
- Evaluate the quality of the partitioning design choices you make

## Get Started

Explore these examples to apply this approach to your next hybrid beamforming project:

- [\*Introduction to Hybrid Beamforming\*](#)
- [\*Hybrid MIMO Beamforming with QSHB and HBPS Algorithms\*](#)
- [\*Massive MIMO Hybrid Beamforming\*](#)
- [\*Modeling an RF mmWave Transmitter with Hybrid Beamforming\*](#)