



Model-Based Calibration For Automotive Traction Motors

Daniel Berry

Technical Specialist – Electric Drive Integration
May 5, 2021

Outline



- Motivation for use of Model-Based Calibration (MBC)
- Overview of MBC
- Step by Step workflow with results
- Wrap up / future work

Motivation For MBC



- With 30 new electric vehicles planned to launch globally by 2025¹, General Motors is continually looking for ways to improve and optimize the process it uses for calibration of electric drive systems
 - Improved speed both in required calibration time and in data processing
 - A scalable and standardized workflow
 - Improved data quality checks to ensure first time quality



general motors



MBC As A Solution



- The Model-Based Calibration Toolbox can be used to address many of these areas for improvement.
 - Utilizing built in optimization features for both Design of Experiment (DOE) definition and model fitting of results reduces computation time vs. full factorial type searches.
 - Having a standardized tool and workflow ensures consistency between multiple users and enforces a consistent process.
 - Implementing various “check points” in the process ensures the quality of the eventual product.
- Using MBC Toolbox, GM electric drive calibration was able to achieve similar results as with in house tools; while improving many of the areas mentioned above.

Model-Based Calibration Workflow and Results



- Overview of electric drive calibration
- Detailed workflow of MBC
 - DOE
 - Data Modeling
 - Calibration
 - Implementation
 - Results
- Future Work

Electric Drive Control System Overview

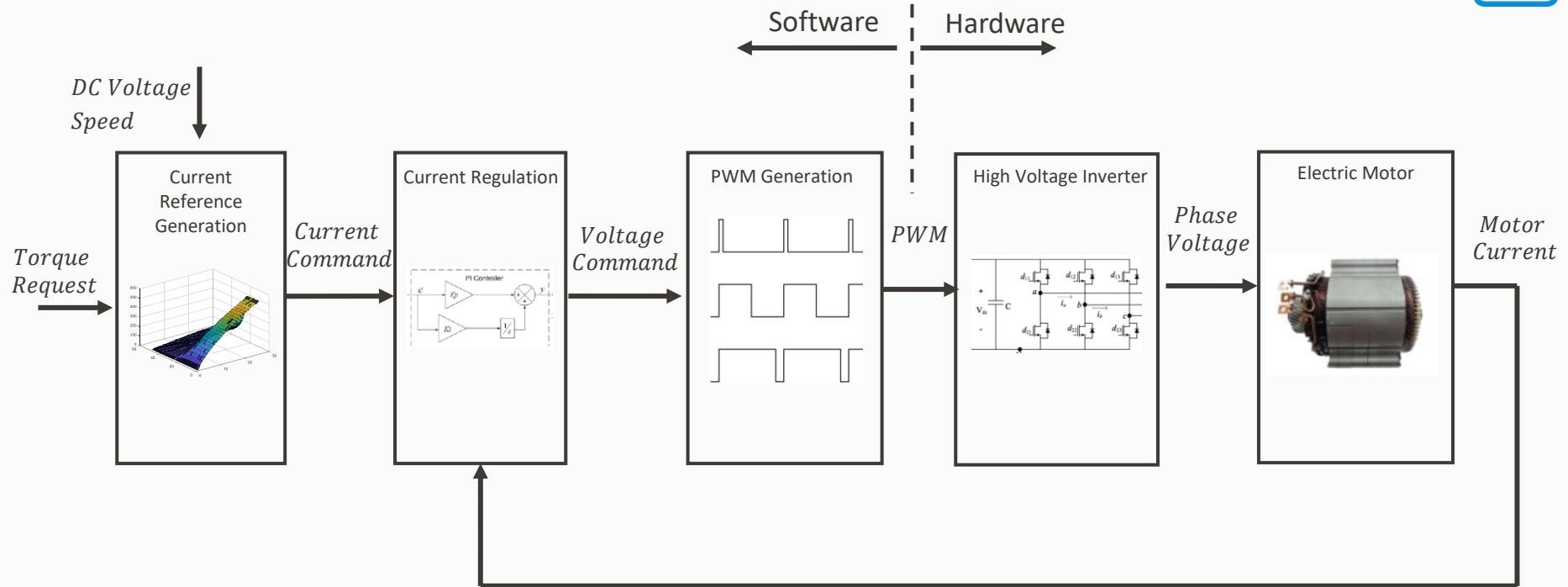

Electric Drive Control System Overview

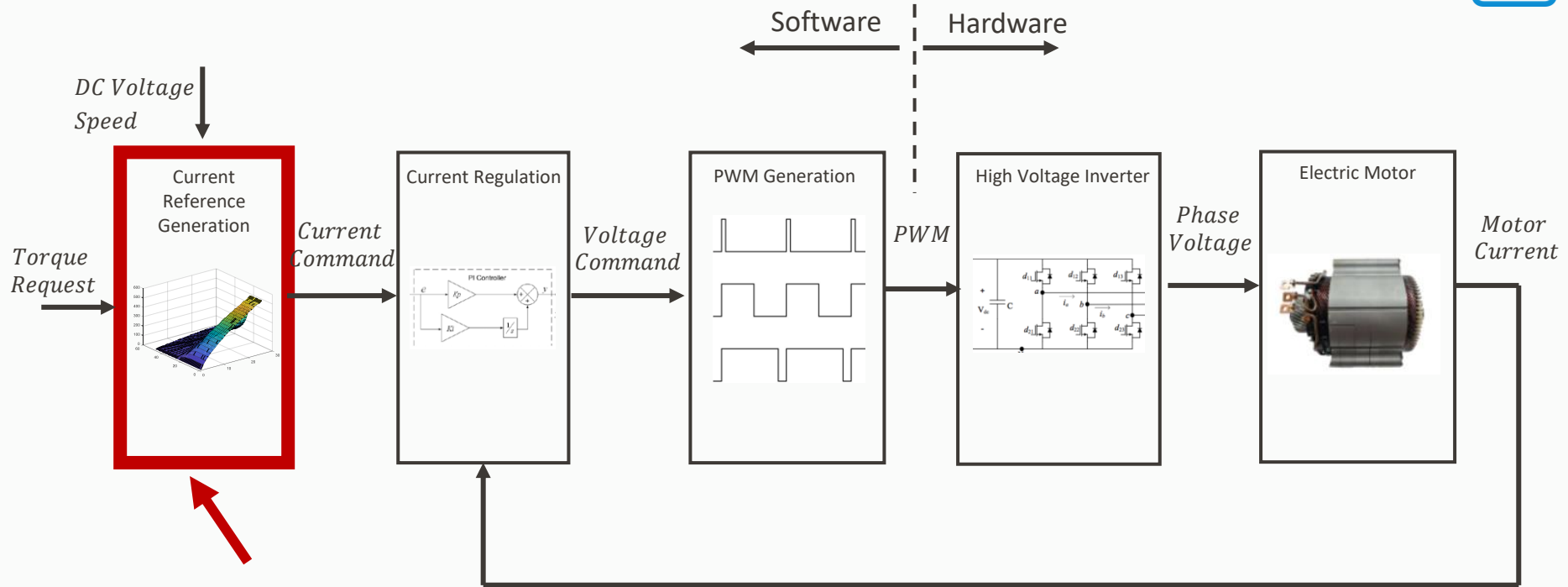

How to Determine the Optimal Current Command Generation For Each Speed, Torque, and Voltage Combination?

Basic Problem Of Electric Machine Calibration



$$T_e = 3/2 P(\lambda_d i_q - \lambda_q i_d) \leftarrow \text{Maximize Torque}$$

$$\sqrt{i_d^2 + i_q^2} < I_{Limit} \leftarrow \text{Minimize Current}$$

$$\begin{aligned} V_q &= r_s i_q + w_e \lambda_d + \frac{d\lambda_q}{dt} \\ V_d &= r_s i_d - w_e \lambda_q + \frac{d\lambda_d}{dt} \end{aligned} \left. \vphantom{\begin{aligned} V_q \\ V_d \end{aligned}} \right\} \text{Constrained By Voltage}$$

$$\lambda_{dq}(i_d, i_q) \leftarrow \text{For all Parameter Variation}$$

Consider a typical automotive traction motor requirements:

- 300Nm Torque
- 10,000RPM Max Speed
- 250 – 450 Vdc Operating Voltage

Even assuming a relatively coarse calibration space of:

- 10Nm Increment
- 250RPM Speed Increments
- 50Vdc Voltage Increments

6000 Points that need to be calibrated

Model-Based Calibration Approach



- Instead of calibrating the current reference tables point by point, we can make use of the known machine characterization data to define data-driven models of the electric machine, then generate the current reference tables according to optimization results.
- This is the idea behind model-based calibration; for which the MathWorks MBC Toolbox can be used.



DoE

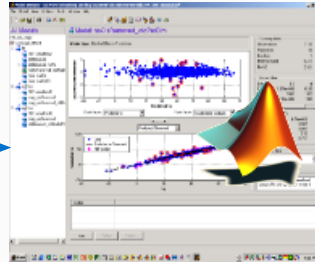

Data Modeling

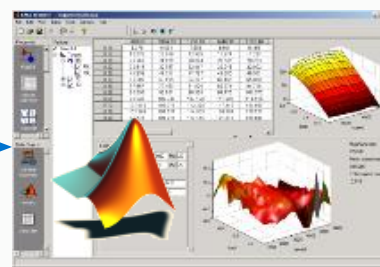
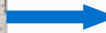

Calibration

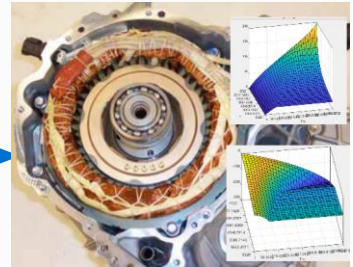
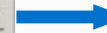

Implementation

Model-Based Calibration Workflow Overview

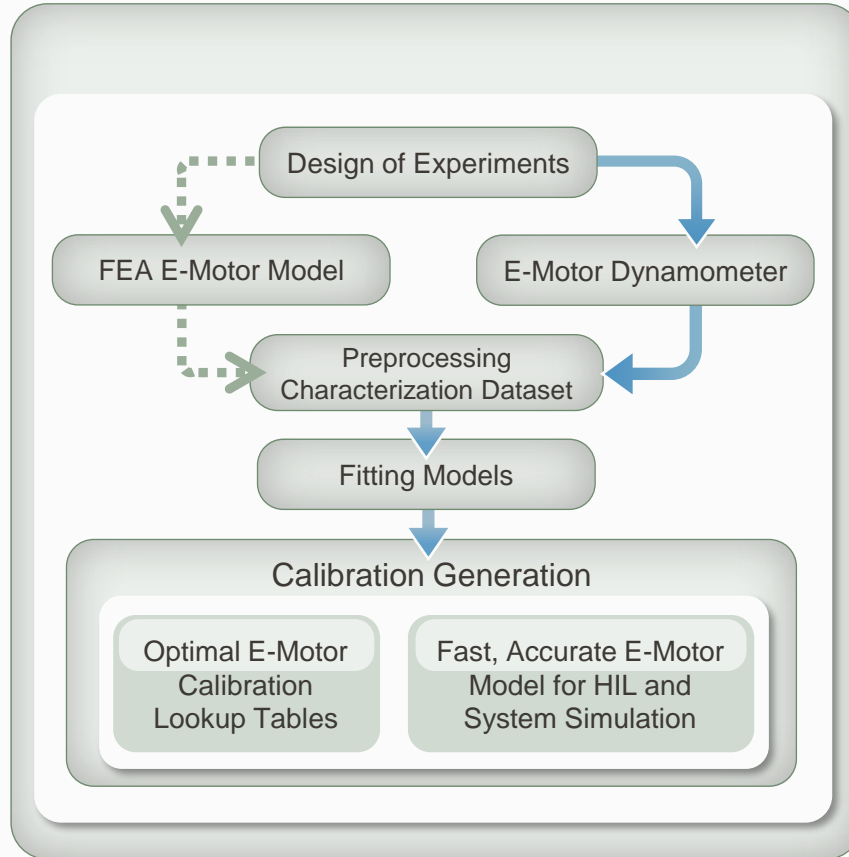

Model-Based Calibration Workflow

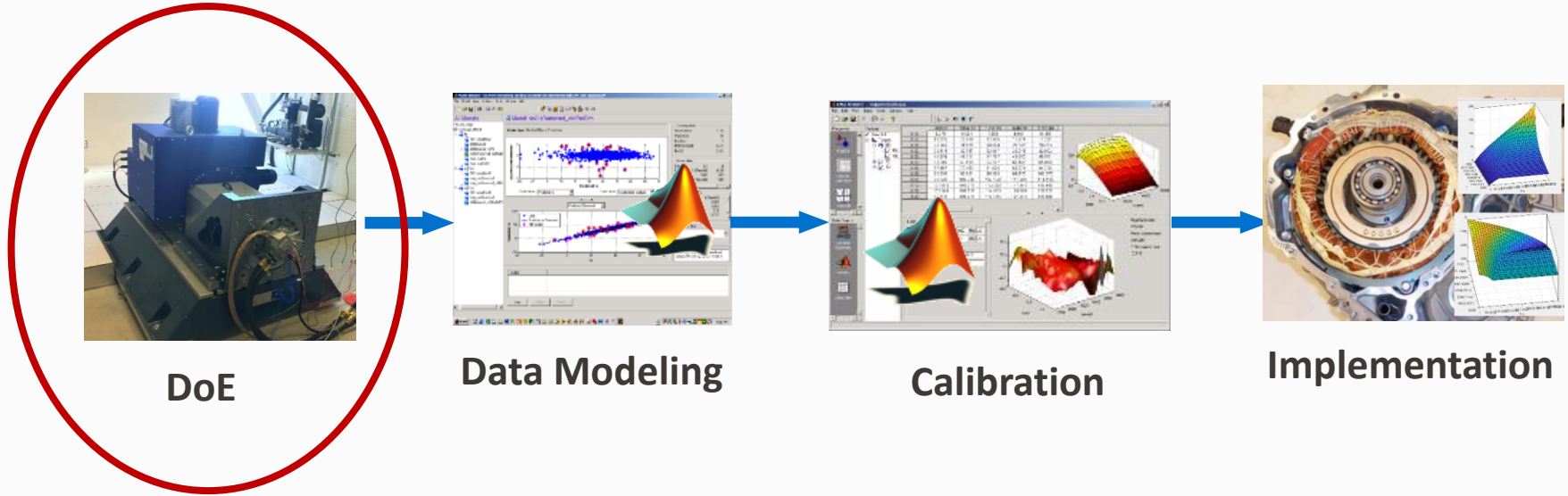



DOE Step Overview

- In order to utilize the machine equations to generate the calibrations, the flux characteristics of the machine need to first be determined.
- The machine flux can be determined at various combinations of D and Q axis currents, as well as speeds to ensure the entire operating space is characterized
- The DOE tool within MBC can be used to define the DOE with an optimal number of points using several built-in space filling techniques

$$T_e = \frac{3}{2} P (\lambda_d i_q - \lambda_q i_d)$$

$$V_q = r_s i_q + w_e \lambda_d + \frac{d\lambda_q}{dt}$$

$$V_d = r_s i_d - w_e \lambda_q + \frac{d\lambda_d}{dt}$$

Steady State

D and Q Axis Flux Based on D and Q Axis Current

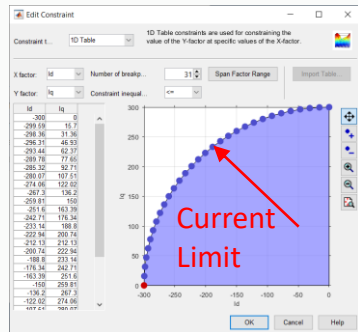

Set up Constraints

general motors

Higher resolution here

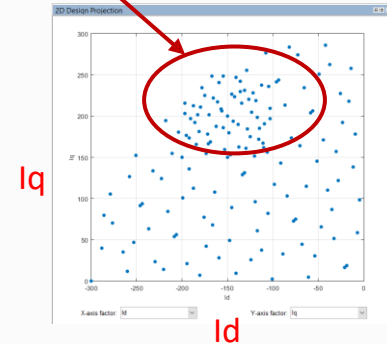

Generate DoE

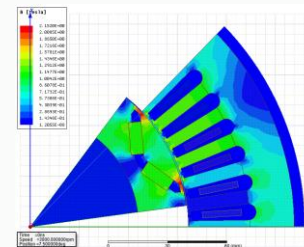
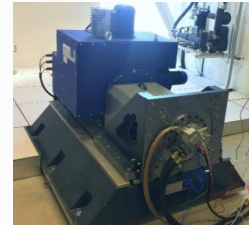

Test or Analyze

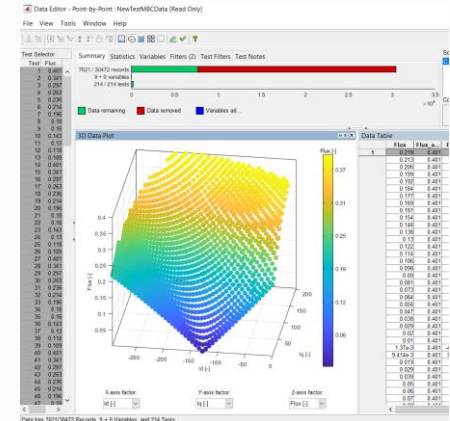

Characterization Complete

Model-Based Calibration Workflow

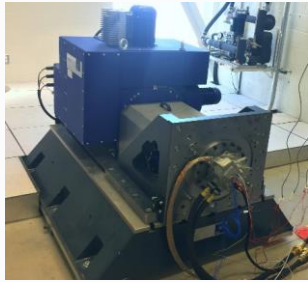

DoE

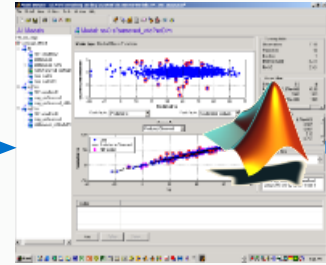
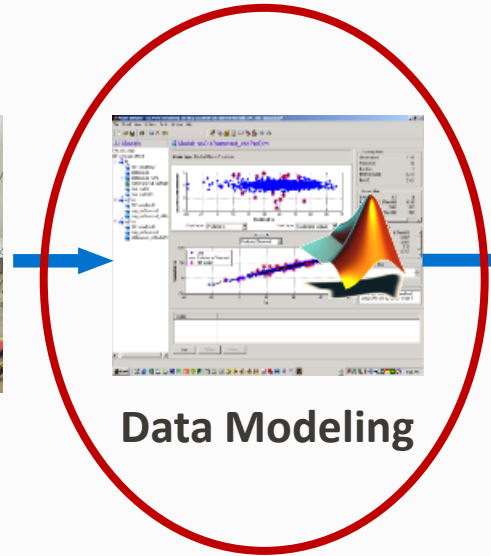

Data Modeling

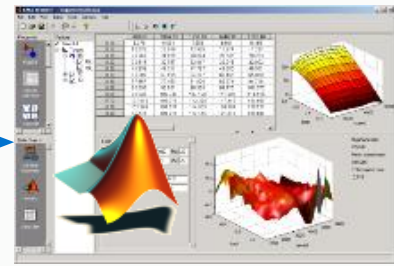

Calibration

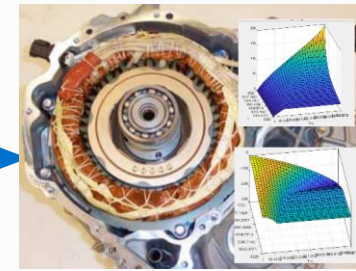

Implementation

Data Modeling Overview

- Machine model is now generated using the characterized machine parameters
- For each speed and voltage, a response surface between the input D axis current and torque and the output Q axis current and flux can be developed
- This response surface will be used in later steps as the basis of the calibration.
- Data outliers can be removed in this step

The error between the model and the test results can be determined and used as a quality check on the model fitting results

Model Parameter Overview

Operating Points – Speed @ Given DC Voltage
Inputs – D Axis Current & Torque
Responses – Q Axis Current and Flux

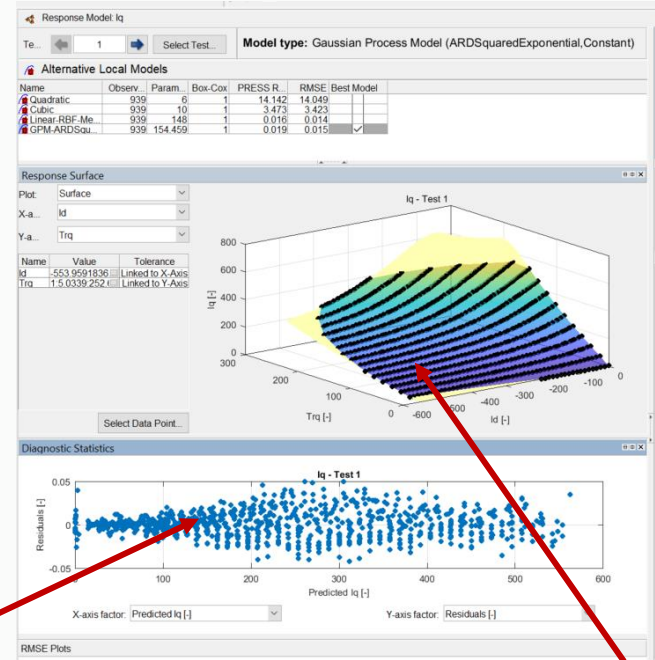

Individual points represent tested points from previous DOE, and surface represents fitted model

Model-Based Calibration Workflow

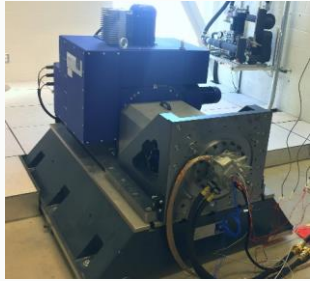

DoE

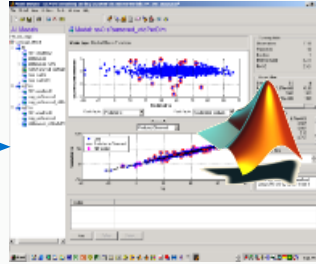
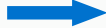

Data Modeling

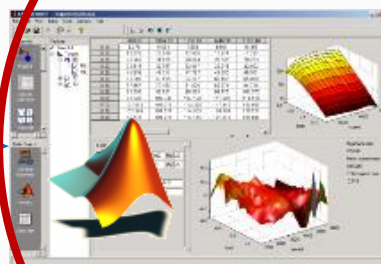
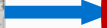

Calibration

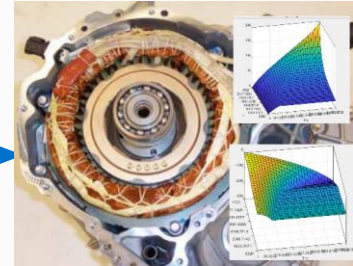

Implementation

Calibration



- Step 1 – Define Constraints
 - Current < Current Max
 - Flux < Maximum Allowable Flux (voltage constraints based on DC voltage, modulation index, stator voltage drop, and speed)
- Step 2 – Define Objectives
 - Maximum Torque/Amp
 - Maximum Torque/Volt
 - Others as appropriate for application

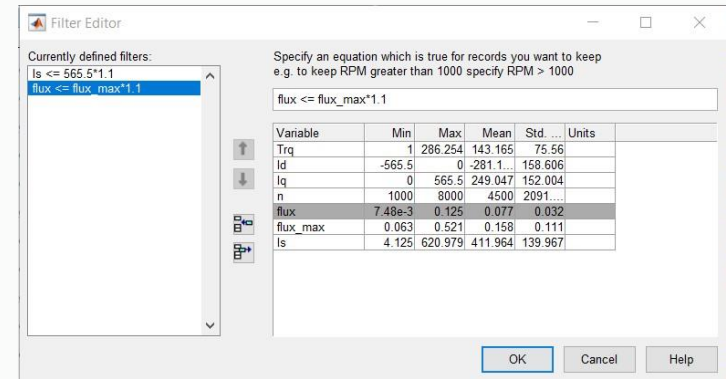
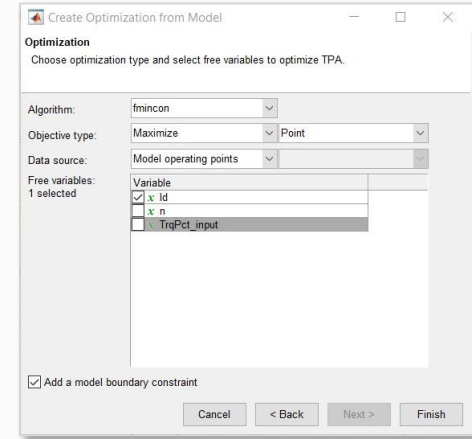

*This step is done using the CALibration GEneration (CAGE) tool in the MBC Toolbox

Calibration Generation (CAGE)

- Using the model response surface
- Generate response surfaces and contours for each operating condition
- Maximize TPA for each operating point

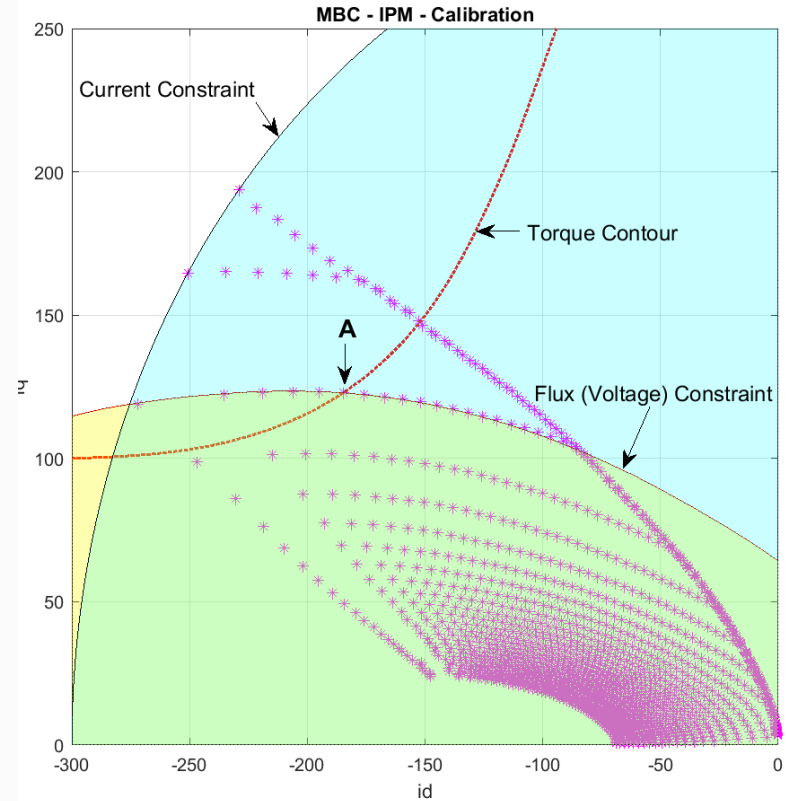

MBC Calibration process explained on the i_d - i_q plane



Generate Torque Envelope

- As a first step, CAGE will be used to find the maximum operating torque envelope of the system given the specified constraints.
- This step forms the boundary around which the current command tables will be generated
 - Performed for different DC voltage levels

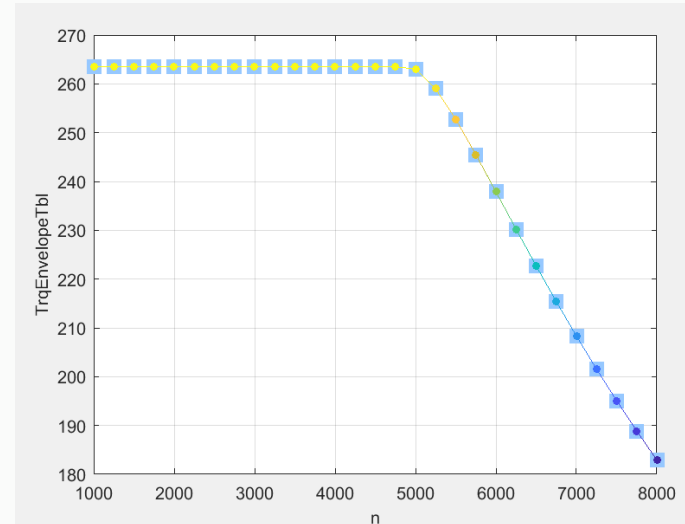
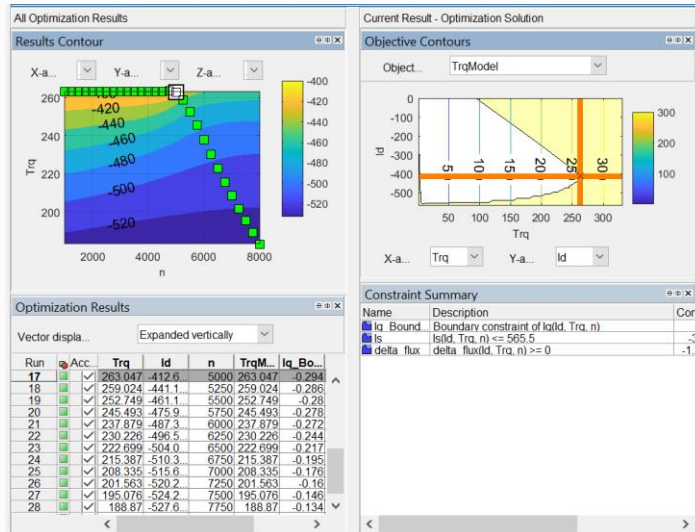

Generate torque envelope at different DC voltages

Calibration Generation (CAGE)



Given the fitted models, where is the best (i_d , i_q) operating points that can achieve pre-set optimization objective while satisfying certain physical constraints.

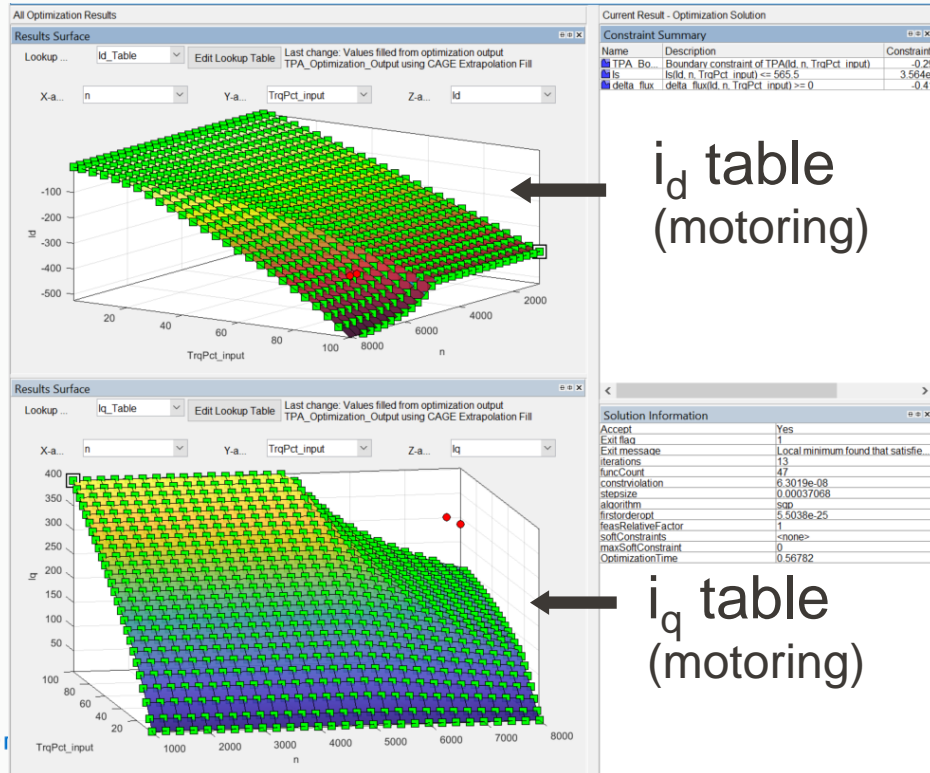

Optimization objective: maximize efficiency
(Torque per Amp)

Constraints: current <= current_max
flux <= flux_allowable

Model-Based Calibration Workflow

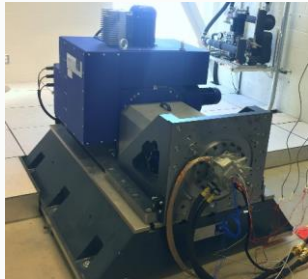

DoE

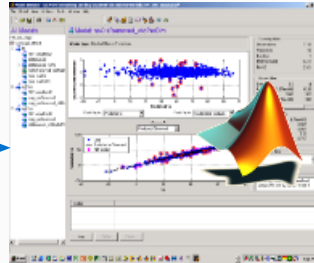
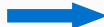

Data Modeling

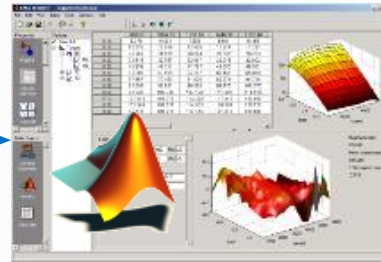
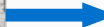

Calibration

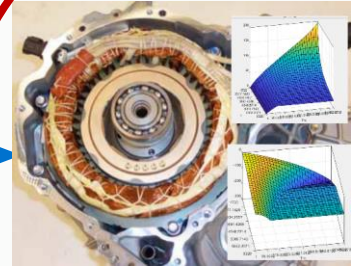

Implementation

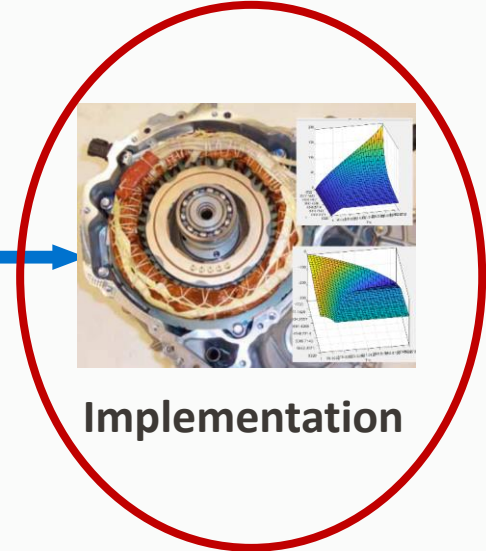

Implementation



- Once current reference tables are developed, they can be programmed into software and tested on the physical hardware.
- Plotted below are is a comparison of the peak torque envelope from calibrations developed using the MBC Toolbox, with those developed from existing processes
- **MBC Toolbox is able to achieve similar performance with existing calibration processes but in a more automated and scalable manner.**

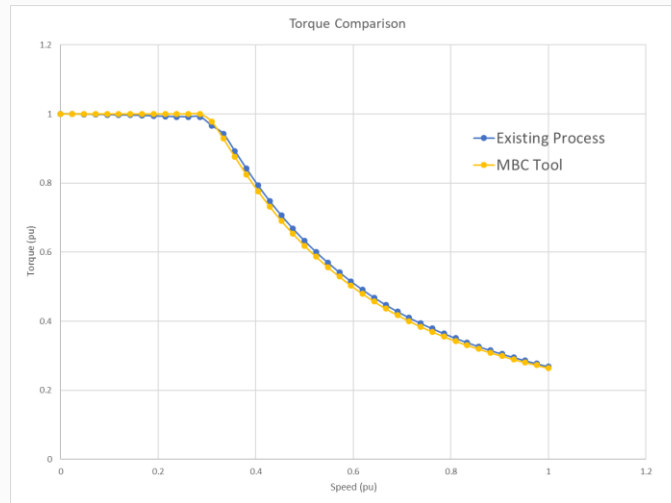



Advantages of Model-Based Calibration Toolbox

- Speed
 - Full table generation can be done in 2-3 minutes for optimization step (after pre-processing)
 - Pre-processing time dependent on resolution of data
- Process Consistency
 - By using a purposely built tool, with automation capability, consistency across different applications and different users can be ensured
 - Opportunity to put in data quality check points and not allow users to proceed without meeting pre-defined metrics
 - Allows for a wider audience of users



Wrap Up / Future Work

- Model-Based Calibration Toolbox was successfully demonstrated to produce comparable results to existing in house tools.
 - Similar peak torque envelopes demonstrated
 - Similar current reference tables generated
- Additional tools, such as App Designer, can be used to customize the MBC user interface such that the entire calibration workflow can be fully automated