

Virtual Engine Calibration Optimization (VECO)

Peter J Maloney, MathWorks Consulting

MathWorks

AUTOMOTIVE CONFERENCE 2015



Outline

- Calibration After Engine Build Slows Design Iterations By About 4 Years
- 4 Year Design Iteration Delay Can Be Removed With
 - GT-POWER co-simulation (Simulink)
 - Direct optimization of engine calibration maps (StateFlow)
 - Rapid calibration development (Parallel Computing)

What Was Engine Calibration?

Sketch

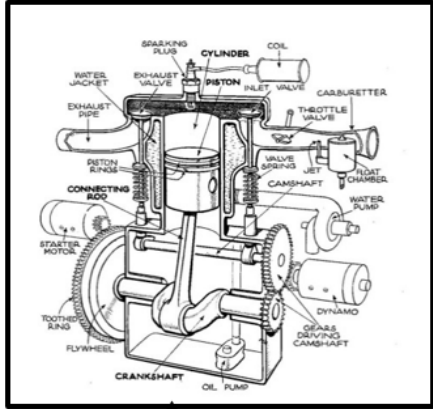

Model

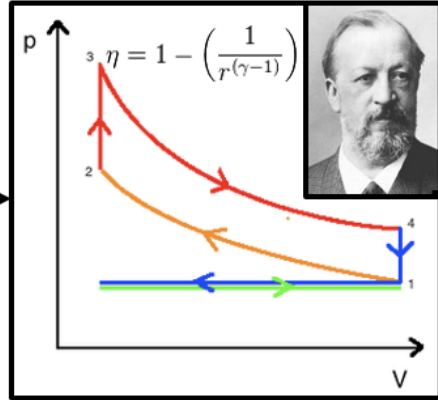

Build

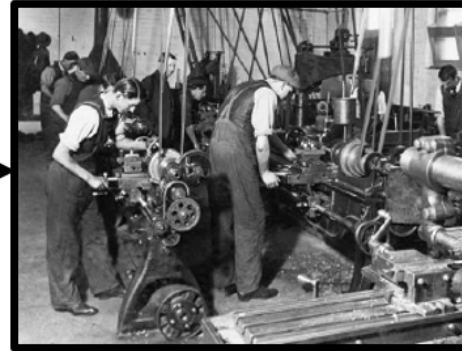

Test

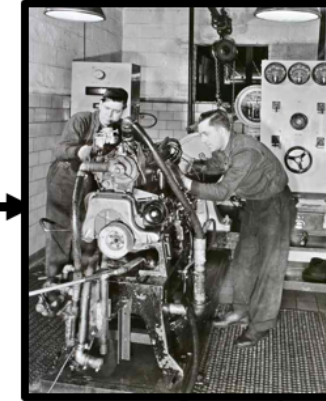

Engine's Performance
Cannot Be Judged
Until It Is Calibrated

Iterate: 4 year delay



“Calibrate” By Adjusting A Few Screws

What Is Typical Engine Calibration Now?

Model and Design

Build

Test

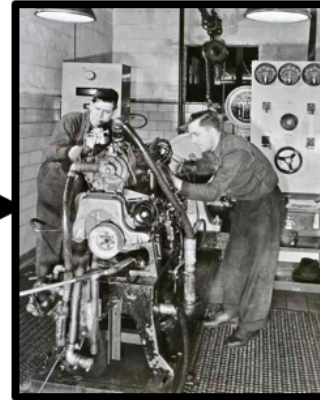
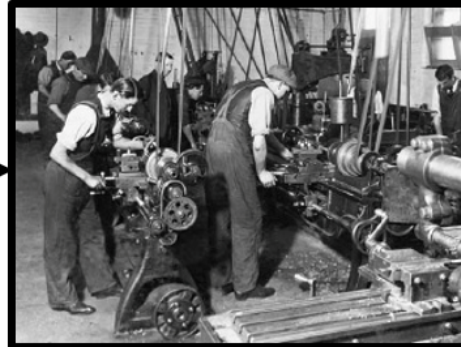
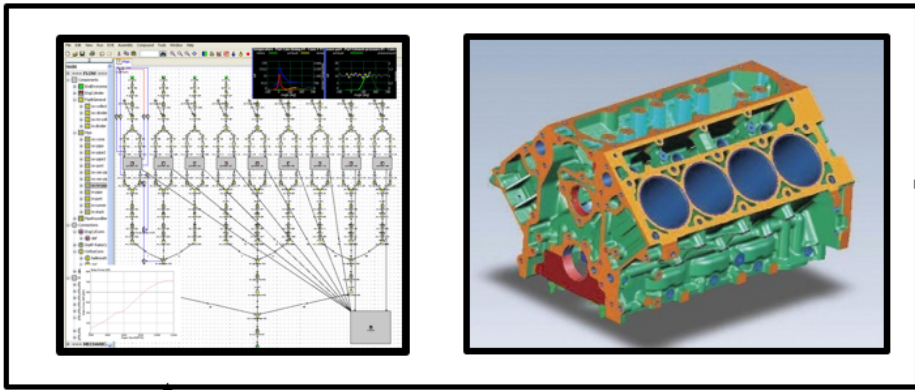

Iterate: 4 year delay

Engine's Performance Cannot Be Judged Until It Is Calibrated



Engine Controller

<p>Table 1.1: Spark Advance</p> <p>Ignition Timing ①</p>	<p>Table 1.2: Wastegate Area</p> <p>Turbo Wastegate Area ③</p>	<p>Table 1.3: Intake Cam Phase</p> <p>Intake Cam Phaser ⑤</p>
<p>Table 1.4: Throttle Position</p> <p>Throttle Position ②</p>	<p>Table 1.5: Air/Fuel Ratio</p> <p>Air/Fuel Ratio ④</p>	<p>Table 1.6: Exhaust Cam Phase</p> <p>Exhaust Cam Phaser ⑥</p>



Engineer

Calibrate By Adjusting 1350 Numbers

What Is Advanced Engine Calibration Now?

Model, Experiment, Fit, Optimize

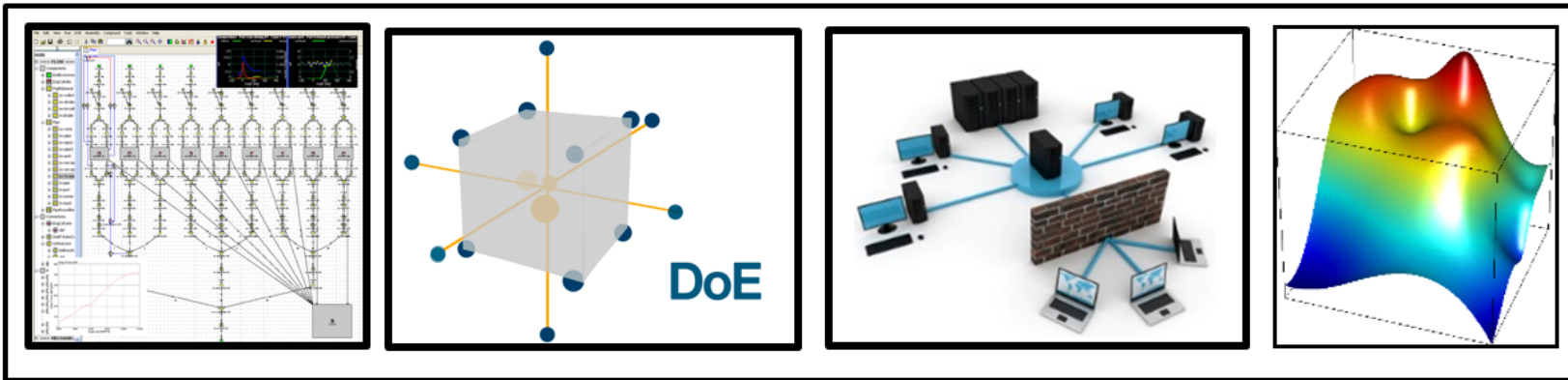

3 day wait on
32 Core Cluster



<p>Table 3.6. Spark Advance</p> <table border="1"> <tr><td>151</td><td>152</td><td>153</td><td>154</td><td>155</td><td>156</td><td>157</td><td>158</td><td>159</td><td>160</td><td>161</td><td>162</td><td>163</td><td>164</td><td>165</td><td>166</td><td>167</td><td>168</td><td>169</td><td>170</td><td>171</td><td>172</td><td>173</td><td>174</td><td>175</td><td>176</td><td>177</td><td>178</td><td>179</td><td>180</td><td>181</td><td>182</td><td>183</td><td>184</td><td>185</td><td>186</td><td>187</td><td>188</td><td>189</td><td>190</td><td>191</td><td>192</td><td>193</td><td>194</td><td>195</td><td>196</td><td>197</td><td>198</td><td>199</td><td>200</td></tr> </table> <p>Ignition Timing ①</p>	151	152	153	154	155	156	157	158	159	160	161	162	163	164	165	166	167	168	169	170	171	172	173	174	175	176	177	178	179	180	181	182	183	184	185	186	187	188	189	190	191	192	193	194	195	196	197	198	199	200	<p>Table 3.7. Wastegate Area</p> <table border="1"> <tr><td>151</td><td>152</td><td>153</td><td>154</td><td>155</td><td>156</td><td>157</td><td>158</td><td>159</td><td>160</td><td>161</td><td>162</td><td>163</td><td>164</td><td>165</td><td>166</td><td>167</td><td>168</td><td>169</td><td>170</td><td>171</td><td>172</td><td>173</td><td>174</td><td>175</td><td>176</td><td>177</td><td>178</td><td>179</td><td>180</td><td>181</td><td>182</td><td>183</td><td>184</td><td>185</td><td>186</td><td>187</td><td>188</td><td>189</td><td>190</td><td>191</td><td>192</td><td>193</td><td>194</td><td>195</td><td>196</td><td>197</td><td>198</td><td>199</td><td>200</td></tr> </table> <p>Turbo Wastegate Area ③</p>	151	152	153	154	155	156	157	158	159	160	161	162	163	164	165	166	167	168	169	170	171	172	173	174	175	176	177	178	179	180	181	182	183	184	185	186	187	188	189	190	191	192	193	194	195	196	197	198	199	200	<p>Table 3.9. Intake Cam Phase Angle</p> <table border="1"> <tr><td>151</td><td>152</td><td>153</td><td>154</td><td>155</td><td>156</td><td>157</td><td>158</td><td>159</td><td>160</td><td>161</td><td>162</td><td>163</td><td>164</td><td>165</td><td>166</td><td>167</td><td>168</td><td>169</td><td>170</td><td>171</td><td>172</td><td>173</td><td>174</td><td>175</td><td>176</td><td>177</td><td>178</td><td>179</td><td>180</td><td>181</td><td>182</td><td>183</td><td>184</td><td>185</td><td>186</td><td>187</td><td>188</td><td>189</td><td>190</td><td>191</td><td>192</td><td>193</td><td>194</td><td>195</td><td>196</td><td>197</td><td>198</td><td>199</td><td>200</td></tr> </table> <p>Intake Cam Phaser ⑤</p>	151	152	153	154	155	156	157	158	159	160	161	162	163	164	165	166	167	168	169	170	171	172	173	174	175	176	177	178	179	180	181	182	183	184	185	186	187	188	189	190	191	192	193	194	195	196	197	198	199	200
151	152	153	154	155	156	157	158	159	160	161	162	163	164	165	166	167	168	169	170	171	172	173	174	175	176	177	178	179	180	181	182	183	184	185	186	187	188	189	190	191	192	193	194	195	196	197	198	199	200																																																																																																							
151	152	153	154	155	156	157	158	159	160	161	162	163	164	165	166	167	168	169	170	171	172	173	174	175	176	177	178	179	180	181	182	183	184	185	186	187	188	189	190	191	192	193	194	195	196	197	198	199	200																																																																																																							
151	152	153	154	155	156	157	158	159	160	161	162	163	164	165	166	167	168	169	170	171	172	173	174	175	176	177	178	179	180	181	182	183	184	185	186	187	188	189	190	191	192	193	194	195	196	197	198	199	200																																																																																																							
<p>Table 3.2. Throttle Position</p> <table border="1"> <tr><td>151</td><td>152</td><td>153</td><td>154</td><td>155</td><td>156</td><td>157</td><td>158</td><td>159</td><td>160</td><td>161</td><td>162</td><td>163</td><td>164</td><td>165</td><td>166</td><td>167</td><td>168</td><td>169</td><td>170</td><td>171</td><td>172</td><td>173</td><td>174</td><td>175</td><td>176</td><td>177</td><td>178</td><td>179</td><td>180</td><td>181</td><td>182</td><td>183</td><td>184</td><td>185</td><td>186</td><td>187</td><td>188</td><td>189</td><td>190</td><td>191</td><td>192</td><td>193</td><td>194</td><td>195</td><td>196</td><td>197</td><td>198</td><td>199</td><td>200</td></tr> </table> <p>Throttle Position ②</p>	151	152	153	154	155	156	157	158	159	160	161	162	163	164	165	166	167	168	169	170	171	172	173	174	175	176	177	178	179	180	181	182	183	184	185	186	187	188	189	190	191	192	193	194	195	196	197	198	199	200	<p>Table 3.8. Lambda</p> <table border="1"> <tr><td>151</td><td>152</td><td>153</td><td>154</td><td>155</td><td>156</td><td>157</td><td>158</td><td>159</td><td>160</td><td>161</td><td>162</td><td>163</td><td>164</td><td>165</td><td>166</td><td>167</td><td>168</td><td>169</td><td>170</td><td>171</td><td>172</td><td>173</td><td>174</td><td>175</td><td>176</td><td>177</td><td>178</td><td>179</td><td>180</td><td>181</td><td>182</td><td>183</td><td>184</td><td>185</td><td>186</td><td>187</td><td>188</td><td>189</td><td>190</td><td>191</td><td>192</td><td>193</td><td>194</td><td>195</td><td>196</td><td>197</td><td>198</td><td>199</td><td>200</td></tr> </table> <p>Air/Fuel Ratio ④</p>	151	152	153	154	155	156	157	158	159	160	161	162	163	164	165	166	167	168	169	170	171	172	173	174	175	176	177	178	179	180	181	182	183	184	185	186	187	188	189	190	191	192	193	194	195	196	197	198	199	200	<p>Table 3.8. Exhaust Cam Phase Angle</p> <table border="1"> <tr><td>151</td><td>152</td><td>153</td><td>154</td><td>155</td><td>156</td><td>157</td><td>158</td><td>159</td><td>160</td><td>161</td><td>162</td><td>163</td><td>164</td><td>165</td><td>166</td><td>167</td><td>168</td><td>169</td><td>170</td><td>171</td><td>172</td><td>173</td><td>174</td><td>175</td><td>176</td><td>177</td><td>178</td><td>179</td><td>180</td><td>181</td><td>182</td><td>183</td><td>184</td><td>185</td><td>186</td><td>187</td><td>188</td><td>189</td><td>190</td><td>191</td><td>192</td><td>193</td><td>194</td><td>195</td><td>196</td><td>197</td><td>198</td><td>199</td><td>200</td></tr> </table> <p>Exhaust Cam Phaser ⑥</p>	151	152	153	154	155	156	157	158	159	160	161	162	163	164	165	166	167	168	169	170	171	172	173	174	175	176	177	178	179	180	181	182	183	184	185	186	187	188	189	190	191	192	193	194	195	196	197	198	199	200
151	152	153	154	155	156	157	158	159	160	161	162	163	164	165	166	167	168	169	170	171	172	173	174	175	176	177	178	179	180	181	182	183	184	185	186	187	188	189	190	191	192	193	194	195	196	197	198	199	200																																																																																																							
151	152	153	154	155	156	157	158	159	160	161	162	163	164	165	166	167	168	169	170	171	172	173	174	175	176	177	178	179	180	181	182	183	184	185	186	187	188	189	190	191	192	193	194	195	196	197	198	199	200																																																																																																							
151	152	153	154	155	156	157	158	159	160	161	162	163	164	165	166	167	168	169	170	171	172	173	174	175	176	177	178	179	180	181	182	183	184	185	186	187	188	189	190	191	192	193	194	195	196	197	198	199	200																																																																																																							

How Do We Speed Up Engine Design?

Model and Calibrate

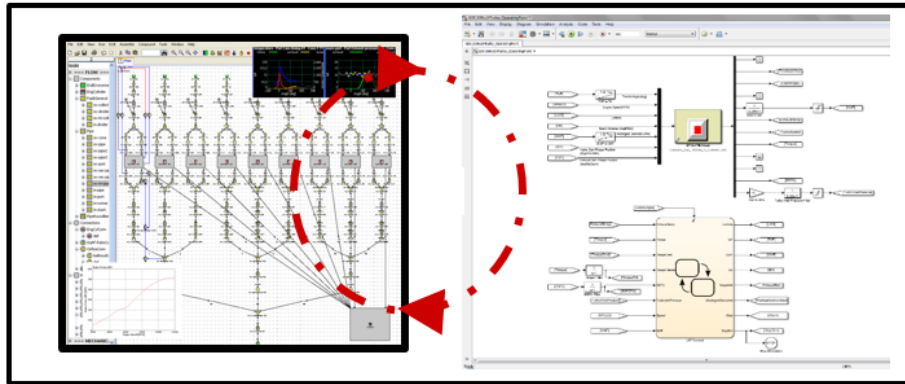

18 day wait
on 1 Core

<p>Table 1.6. Spark Advance</p> <p>Ignition Timing ①</p>	<p>Table 1.8. Wastegate Area</p> <p>Turbo Wastegate Area ③</p>	<p>Table 1.9 Intake Cam Phaser Angle</p> <p>Intake Cam Phaser ⑤</p>
<p>Table 1.2. Throttle Position</p> <p>Throttle Position ②</p>	<p>Table 1.4. Lambda</p> <p>Air/Fuel Ratio ④</p>	<p>Table 1.11. Exhaust Cam Phaser Angle</p> <p>Exhaust Cam Phaser ⑥</p>

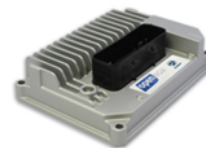

Engine Controller



How Do We Speed Up Engine Design?

Model and Calibrate

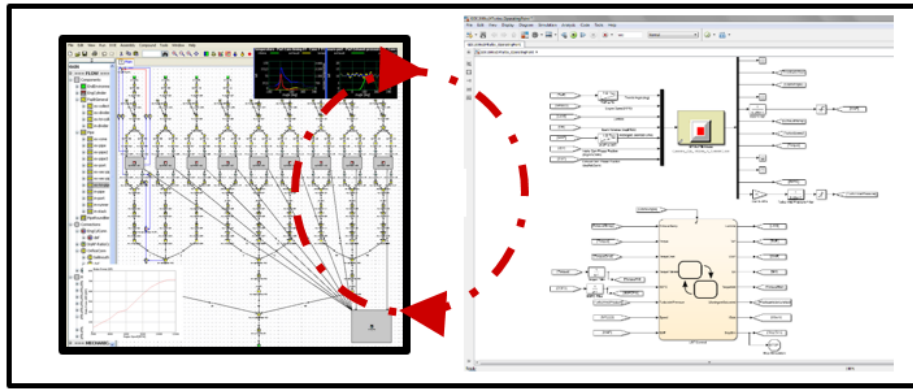

2hr wait

225 Cores

<p>Table 3.6. Spark Advance</p> <p>① Ignition Timing</p>	<p>Table 3.8. Turbo Wastegate Area</p> <p>③ Turbo Wastegate Area</p>	<p>Table 3.7 Intake Cam Phaser Angl</p> <p>⑤ Intake Cam Phaser</p>
<p>Table 3.2 Throttle Position</p> <p>② Throttle Position</p>	<p>Table 3.4 Lambda</p> <p>④ Air/Fuel Ratio</p>	<p>Table 3.5 Exhaust Cam Phaser Angl</p> <p>⑥ Exhaust Cam Phaser</p>

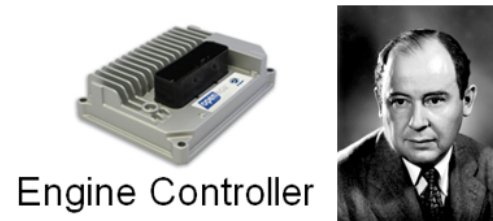

Engine Controller



Calibrate 1350 Numbers via Numerical Optimization

Base Engine Calibration Problem Addressed by VECO

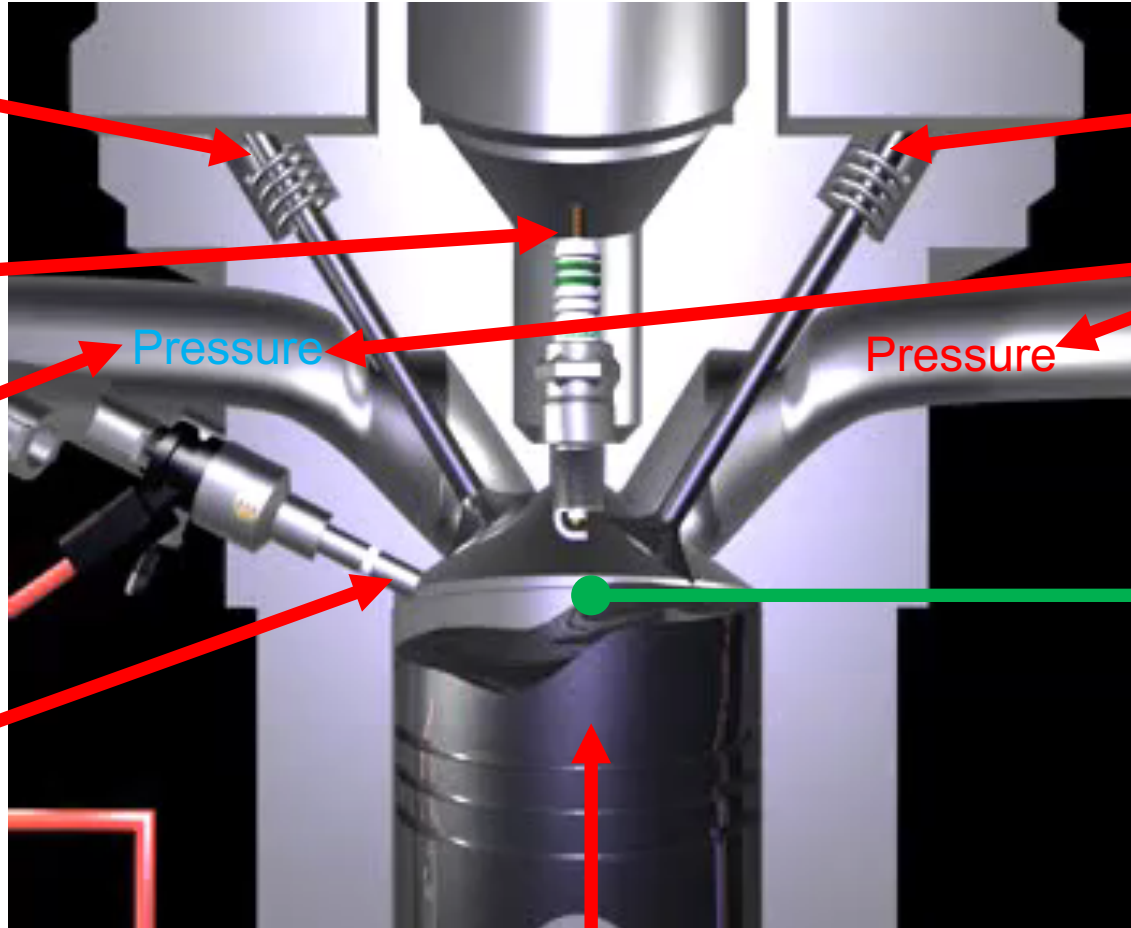

Intake Cam Phasing

⑤

① Ignition Timing

② Throttle Position

④ Fuel
→ Air/Fuel Ratio

Exhaust Cam Phasing

⑥ → NOx

Turbo Wastegate Area
③

Cylinder Pressure
→ Torque
(15 Operating Levels)

Speed (15 Operating Levels)



Calibrations Produced By VECO Process

Table 3.6. Spark Advance

	750	1054	1357	1661	1964	2268	2571	2875	3179	3482	3786	4089	4393	4696	5000
15	21	26	31	34	37	40	47	50	49	50	50	50	50	57	63
26	14	20	24	28	32	35	40	45	49	50	50	50	50	50	53
38	11	17	21	25	29	33	38	41	46	50	50	50	50	50	50
49	10	15	20	24	28	31	35	39	43	48	50	50	49	50	50
61	8	11	19	23	26	29	34	38	41	46	50	50	50	50	50
72	7	11	17	22	24	27	32	36	40	44	46	47	48	48	48
84	7	8	11	14	17	21	25	30	36	40	48	50	50	50	50
95	0	13	17	22	24	27	32	36	42	44	46	47	48	48	48
106	0	15	17	21	24	27	31	36	41	42	43	45	45	45	46
118	0	0	17	21	23	27	31	35	37	39	40	42	42	44	45
129	0	0	16	20	23	26	31	32	35	36	38	39	40	42	44
141	0	0	11	19	23	26	29	29	32	34	35	37	38	40	43
152	0	0	0	15	20	24	27	27	30	32	33	35	37	39	41
164	0	0	0	2	17	22	24	24	28	29	32	34	35	37	38
175	0	0	0	0	4	17	21	22	25	27	30	32	33	34	36

Ignition Timing
①

Table 3.8. Lambda

	750	1054	1357	1661	1964	2268	2571	2875	3179	3482	3786	4089	4393	4696	5000
15	1	1	1	1	1	1	1	1	0.97	0.95	0.92	0.86	0.82	0.81	0.81
26	1	1	1	1	1	1	1	1	1	1	0.96	0.89	0.84	0.81	0.81
38	1	1	1	1	1	1	1	1	1	1	1	0.92	0.91	0.88	0.8
49	1	1	1	1	1	1	1	1	1	1	1	0.95	0.88	0.85	0.87
61	1	1	1	1	1	1	1	1	1	1	1	0.96	0.93	0.87	0.85
72	1	1	1	1	1	1	1	1	1	1	1	0.92	0.9	0.92	0.9
84	1	1	1	1	1	1	1	1	1	1	1	0.95	0.89	0.91	0.88
95	1	1	1	1	1	1	1	1	1	0.99	0.97	0.94	0.92	0.91	0.88
106	1	1	1	1	1	1	1	1	1	0.98	0.91	0.92	0.9	0.85	0.85
118	1	0.95	1	1	1	1	1	1	0.96	0.94	0.92	0.86	0.85	0.88	0.85
129	1	0.95	1	1	1	1	1	1	0.97	0.93	0.87	0.84	0.86	0.85	0.84
141	1	0.95	1	1	1	1	1	1	0.96	0.94	0.9	0.85	0.84	0.85	0.84
152	1	0.95	0.85	1	1	1	1	1	0.96	0.92	0.9	0.86	0.84	0.84	0.8
164	1	0.95	0.84	0.8	1	1	1	0.93	0.89	0.84	0.84	0.82	0.8	0.8	0.8
175	1	0.94	0.84	0.8	0.8	0.96	0.96	0.89	0.87	0.84	0.82	0.8	0.8	0.8	0.8

Air/Fuel Ratio
④

Table 3.2. Throttle Position

	750	1054	1357	1661	1964	2268	2571	2875	3179	3482	3786	4089	4393	4696	5000
15	0.6	0.8	1.1	1.4	1.7	2	2.3	2.6	2.9	3.2	3.6	4	4.4	4.8	5.2
26	0.8	1.2	1.6	1.9	2.3	2.6	3	3.4	3.9	4.2	4.7	5.1	5.6	6.2	6.6
38	1.1	1.5	2	2.4	2.9	3.3	3.8	4.3	4.8	5.2	5.8	6.3	6.7	7.3	8
49	1.4	1.8	2.5	3	3.5	4	4.6	5.1	5.7	6.2	6.8	7.4	8	8.7	9.3
61	1.9	2.4	3.3	4	4.7	5.5	6.3	7.3	8	8.8	9.6	10.4	11.2	12.1	13
72	2.8	3.3	3.9	4.6	5.2	5.9	6.5	7.3	8	8.8	9.6	10.4	11.2	12.1	13
84	6.6	5.5	5.5	5.9	6.6	7.5	8	8.9	9.8	11	11.9	12.7	13.7	14.8	15.9
95	100	100	11.1	9.1	9.5	10	11.7	13	14	15.1	16.2	17.4	18.8	20.2	
106	100	100	100	100	25.3	17.1	15	20	20.4	21.9	23.1	24.7	28	29.5	
118	100	100	100	100	100	100	100	97.6	54.9	57	69.1	82.3	85	89.8	
129	100	100	100	100	100	100	100	100	100	100	100	100	100	100	
141	100	100	100	100	100	100	100	100	100	100	100	100	100	100	
152	100	100	100	100	100	100	100	100	100	100	100	100	100	100	
164	100	100	100	100	100	100	100	100	100	100	100	100	100	100	
175	100	100	100	100	100	100	100	100	100	100	100	100	100	100	

Throttle Position
②

Table 3.9 Intake Cam Phaser Angle

	750	1054	1357	1661	1964	2268	2571	2875	3179	3482	3786	4089	4393	4696	5000
15	0	0	1	1	2	2	3	3	22	17	18	21	25	45	0
26	1	0	0	0	0	3	8	19	20	20	25	19	47	48	50
38	1	0	0	0	0	5	15	41	41	48	48	49	45	48	
49	10	2	5	5	5	5	5	5	5	5	5	5	5	5	
61	4	10	35	44	49	49	49	49	48	49	48	45	49	49	
72	0	3	48	48	48	48	49	49	49	47	48	49	50	50	
84	0	5	4	14	14	14	14	14	14	14	14	14	14	14	
95	0	0	3	9	8	8	8	8	8	8	8	8	8	8	
106	0	0	0	0	5	10	0	0	0	7	50	50	50	49	
118	0	0	0	0	0	0	0	0	0	50	50	50	50	49	
129	0	0	0	0	0	0	0	0	0	49	50	50	36	45	
141	0	0	0	0	0	0	0	0	0	49	50	50	36	45	
152	0	0	0	0	0	0	0	0	0	49	50	50	36	45	
164	0	0	0	0	0	0	0	0	0	49	49	50	36	45	
175	0	0	0	0	0	0	0	0	0	49	49	50	36	45	

Intake Cam Phaser
⑤

Table 3.4. Wastegate Area

	750	1054	1357	1661	1964	2268	2571	2875	3179	3482	3786	4089	4393	4696	5000
15	100	100	100	100	100	100	100	100	100	100	100	100	100	100	100
26	100	100	100	100	100	100	100	100	100	100	100	100	100	100	100
38	100	100	100	100	100	100	100	100	100	100	100	100	100	100	100
49	100	100	100	100	100	100	100	100	100	100	100	100	100	100	100
61	100	100	100	100	100	100	100	100	100	100	100	100	100	100	100
72	100	100	100	100	100	100	100	100	100	100	100	100	100	100	100
84	100	100	100	100	100	100	100	100	100	100	100	100	100	100	100
95	0.3	0.3	0.3	0.3	0.3	0.3	0.3	0.3	0.3	0.3	0.3	0.3	0.3	0.3	0.3
106	0.3	0.3	18.9	53.3	100	100	100	100	100	100	100	100	100	100	100
118	0.3	0.3	3.5	19.2	36.6	50.9	60.3	81.5	100	100	100	100	100	100	100
129	0.3	0.3	0.3	10.4	21.6	31.9	43	58.1	63.9	69.9	74	76.4	79.5	82	84.4
141	0.3	0.3	0.3	7.3	16.5	24	33.9	47	54.7	60.4	66.1	70.4	74.5	75.4	75.4
152	0.3	0.3	0.3	6.4	14.3	22	30.4	41.3	50.2	56.3	61.4	64.9	67.4	69.1	71.4
164	0.3	0.3	0.3	5.7	11.7	17.7	26.9	35.5	44.8	49.8	55.4	59.8	62.5	65.7	68.8
175	0.3	0.3	0.3	6.7	12.4	16	24.3	32.5	41	46.8	52.4	56.3	60.6	63.5	65.9

Turbo Wastegate Area
③

Table 3.10. Exhaust Cam Phaser Angle

	750	1054	1357	1661	1964	2268	2571	2875	3179	3482	3786	4089	4393	4696	5000
15	0	0	9	10	9	8	13	3	10	9	2	9	4	7	0
26	9	12	20	22	20	23	3	0	6	6	3	0	11	10	13
38	14	23	22	30	26	5	5	4	2	4	6	6	6	10	18
49	18	28	32	32	29	9	5	5	5	5	2	1	11	16	17
61	27	28	10	5	5	5	5	5	5	5	5	5	5	5	5
72	0	23	2	0	5	6	0	0	1	13	20	16	9	9	18
84	0	8	10	6	6	6	0	0	1	15	15	9	8	9	2
95	0	0	11	5	0	0	0	0	0	9	9	8	8	8	7
106	0	0	7	0	0	3	0	0	0	25	8	8	8	8	6
118	0	0	7	7	0	0	0	0	3	5	8	8	7	7	3
129	0	0	7	7	0	0	0	0	10	20	9	8	8	7	3
141	0	0	7	7	0	0	0	0	0	15	5	8	8	7	3
152	0	0	7	7	0	0	0	0	27	15	5	8	8	7</	

Example VECO At One Operating Point

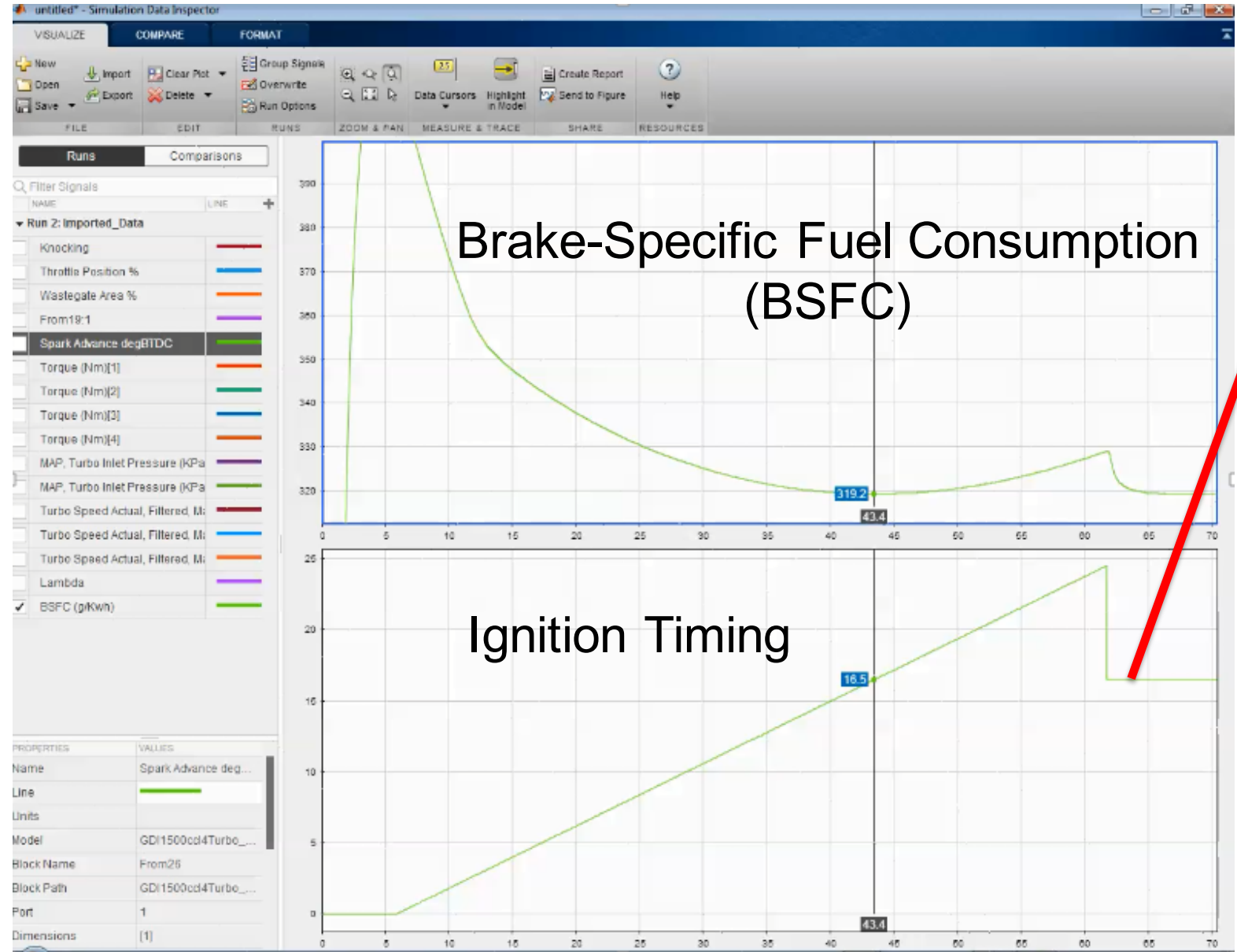

750	1054	1357	1661	1964	2268	2571	2875	3179	3482	3786	4089	4393	4696	5000
15	21	26	31	34	37	40	47	50	49	50	50	50	50	53
26	14	20	24	28	32	35	40	45	49	50	50	50	50	50
38	11	17	21	25	29	33	38	41	46	50	50	50	50	50
49	10	15	20	23	28	31	35	39	43	48	50	50	49	50
61	8	12	16	19	23	27	31	34	38	42	46	50	50	50
72	7	11	15	18	22	25	29	32	36	40	44	48	50	50
84	7	11	15	18	22	25	29	32	36	40	44	48	50	50
95	6	10	14	17	21	24	27	31	35	40	44	48	48	48
106	6	10	14	17	21	24	27	31	35	40	44	48	48	48
118	6	10	14	17	21	24	27	31	35	40	44	48	48	48
129	6	10	14	17	21	24	27	31	35	40	44	48	48	48
141	6	10	14	17	21	24	27	31	35	40	44	48	48	48
152	6	10	14	17	21	24	27	31	35	40	44	48	48	48
164	6	10	14	17	21	24	27	31	35	40	44	48	48	48
175	6	10	14	17	21	24	27	31	35	40	44	48	48	48

750	1054	1357	1661	1964	2268	2571	2875	3179	3482	3786	4089	4393	4696	5000
15	1	1	1	1	1	1	1	1	1	1	1	1	1	1
26	1	1	1	1	1	1	1	1	1	1	1	1	1	1
38	1	1	1	1	1	1	1	1	1	1	1	1	1	1
49	1	1	1	1	1	1	1	1	1	1	1	1	1	1
61	1	1	1	1	1	1	1	1	1	1	1	1	1	1
72	1	1	1	1	1	1	1	1	1	1	1	1	1	1
84	1	1	1	1	1	1	1	1	1	1	1	1	1	1
95	1	1	1	1	1	1	1	1	1	1	1	1	1	1
106	1	1	1	1	1	1	1	1	1	1	1	1	1	1
118	1	1	1	1	1	1	1	1	1	1	1	1	1	1
129	1	1	1	1	1	1	1	1	1	1	1	1	1	1
141	1	1	1	1	1	1	1	1	1	1	1	1	1	1
152	1	1	1	1	1	1	1	1	1	1	1	1	1	1
164	1	1	1	1	1	1	1	1	1	1	1	1	1	1
175	1	1	1	1	1	1	1	1	1	1	1	1	1	1

750	1054	1357	1661	1964	2268	2571	2875	3179	3482	3786	4089	4393	4696	5000
15	0.6	0.8	1.1	1.4	1.7	2.1	2.5	2.9	3.2	3.6	4	4.4	4.8	5.2
26	0.8	1.2	1.6	1.9	2.3	2.6	3	3.4	3.9	4.2	4.7	5.1	5.6	6.2
38	1.1	1.6	2.1	2.4	2.9	3.3	3.8	4.3	4.8	5.2	5.8	6.3	6.9	7.5
49	1.4	1.9	2.5	2.8	3.4	3.8	4.4	5.1	5.6	6.2	6.8	7.4	8.1	8.8
61	1.9	2.5	3.2	3.5	4.2	4.6	5.3	6.1	6.6	7.3	8.1	8.9	9.7	10.5
72	2.8	3.5	4.4	4.7	5.5	6.1	6.9	7.8	8.5	9.4	10.3	11.3	12.3	13.3
84	6.6	5.5	5.5	5.9	6.6	7.5	8	8.9	9.8	11	11.9	12.7	13.7	14.8
95	100	100	11.1	9.1	9.5	10	10	11.7	13	14	15.1	16.2	17.4	18.8
106	100	100	100	100	25.3	11.9	11.9	20.4	21.9	23.1	24.7	28	29.5	31
118	100	100	100	100	100	100	100	97.6	54.9	57	69.1	82.3	85	89.8
129	100	100	100	100	100	100	100	100	100	100	100	100	100	100
141	100	100	100	100	100	100	100	100	100	100	100	100	100	100
152	100	100	100	100	100	100	100	100	100	100	100	100	100	100
164	100	100	100	100	100	100	100	100	100	100	100	100	100	100
175	100	100	100	100	100	100	100	100	100	100	100	100	100	100

750	1054	1357	1661	1964	2268	2571	2875	3179	3482	3786	4089	4393	4696	5000
15	100	100	100	100	100	100	100	100	100	100	100	100	100	100
26	100	100	100	100	100	100	100	100	100	100	100	100	100	100
38	100	100	100	100	100	100	100	100	100	100	100	100	100	100
49	100	100	100	100	100	100	100	100	100	100	100	100	100	100
61	100	100	100	100	100	100	100	100	100	100	100	100	100	100
72	100	100	100	100	100	100	100	100	100	100	100	100	100	100
84	100	100	100	100	100	100	100	100	100	100	100	100	100	100
95	0.3	0.3	0.3	0.3	0.3	0.3	0.3	0.3	0.3	0.3	0.3	0.3	0.3	0.3
106	0.3	0.3	0.3	0.3	0.3	0.3	0.3	0.3	0.3	0.3	0.3	0.3	0.3	0.3
118	0.3	0.3	0.3	0.3	0.3	0.3	0.3	0.3	0.3	0.3	0.3	0.3	0.3	0.3
129	0.3	0.3	0.3	0.3	0.3	0.3	0.3	0.3	0.3	0.3	0.3	0.3	0.3	0.3
141	0.3	0.3	0.3	0.3	0.3	0.3	0.3	0.3	0.3	0.3	0.3	0.3	0.3	0.3
152	0.3	0.3	0.3	0.3	0.3	0.3	0.3	0.3	0.3	0.3	0.3	0.3	0.3	0.3
164	0.3	0.3	0.3	0.3	0.3	0.3	0.3	0.3	0.3	0.3	0.3	0.3	0.3	0.3
175	0.3	0.3	0.3	0.3	0.3	0.3	0.3	0.3	0.3	0.3	0.3	0.3	0.3	0.3

750	1054	1357	1661	1964	2268	2571	2875	3179	3482	3786	4089	4393	4696	5000
15	0	0	0	1	2	3	3	3	3	3	3	3	3	3
26	0	0	0	0	3	5	8	19	20	20	25	19	47	48
38	1	0	0	0	0	0	0	0	0	0	0	0	0	0
49	10	2	5	5	5	5	5	5	5	5	5	5	5	5
61	4	10	35	14	27	49	49	49	49	49	49	49	49	49
72	0	3	48	48	48	48	48	48	48	48	48	48	48	48
84	0	5	4	14	11	11	11	11	11	11	11	11	11	11
95	0	0	3	9	8	11	11	11	11	11	11	11	11	11
106	0	0	0	0	5	10	10	10	10	10	10	10	10	10
118	0	0	0	0	0	0	0	0	0	0	0	0	0	0
129	0	0	0	0	0	0	0	0	0	0	0	0	0	0
141	0	0	0	0	0	0	0	0	0	0	0	0	0	0
152	0	0	0	0	0	0	0	0	0	0	0	0	0	0
164	0	0	0	0	0	0	0	0	0	0	0	0	0	0
175	0	0	0	0	0	0	0	0	0	0	0	0	0	0

750	1054	1357	1661	1964	2268	2571	2875	3179	3482	3786	4089	4393	4696	5000
15	0	0	0	0	0	0	0	0	0	0	0	0	0	0
26	0	12	20	22	20	22	22	22	22	22	22	22	22	22
38	14	23	28	28	28	28	28	28	28	28	28	28	28	28
49	18	25	30	30	30	30	30	30	30	30	30	30	30	30
61	27	28	28	28	28	28	28	28	28	28	28	28	28	28
72	0	23	2	2	0	0	0	0	0	0	0	0	0	0
84	0	8	10	6	0	0	0	0	0	0	0	0	0	0
95	0	0	11	5	1	1	1	1	1	1	1	1	1	1
106	0	0	7	0	0	0	0	0	0	0	0	0	0	0
118	0	0	7	7	0	0	0	0	0	0	0	0	0	0
129	0	0	7	7	0	0	0	0	0	0	0	0	0	0
141	0	0	7	7	0	0	0	0	0	0	0	0	0	0
152	0	0	7	7	0	0	0	0	0	0	0	0	0	0
164	0	0	7	7	0	0	0	0	0	0	0	0	0	0
175	0	0	7	7	0	0	0	0	0	0	0	0	0	0



**1.5L SI DOHC I4 GDI
Dual VCP Turbo
Application Example**

Parallel Computing Used for 225x Speed-Up

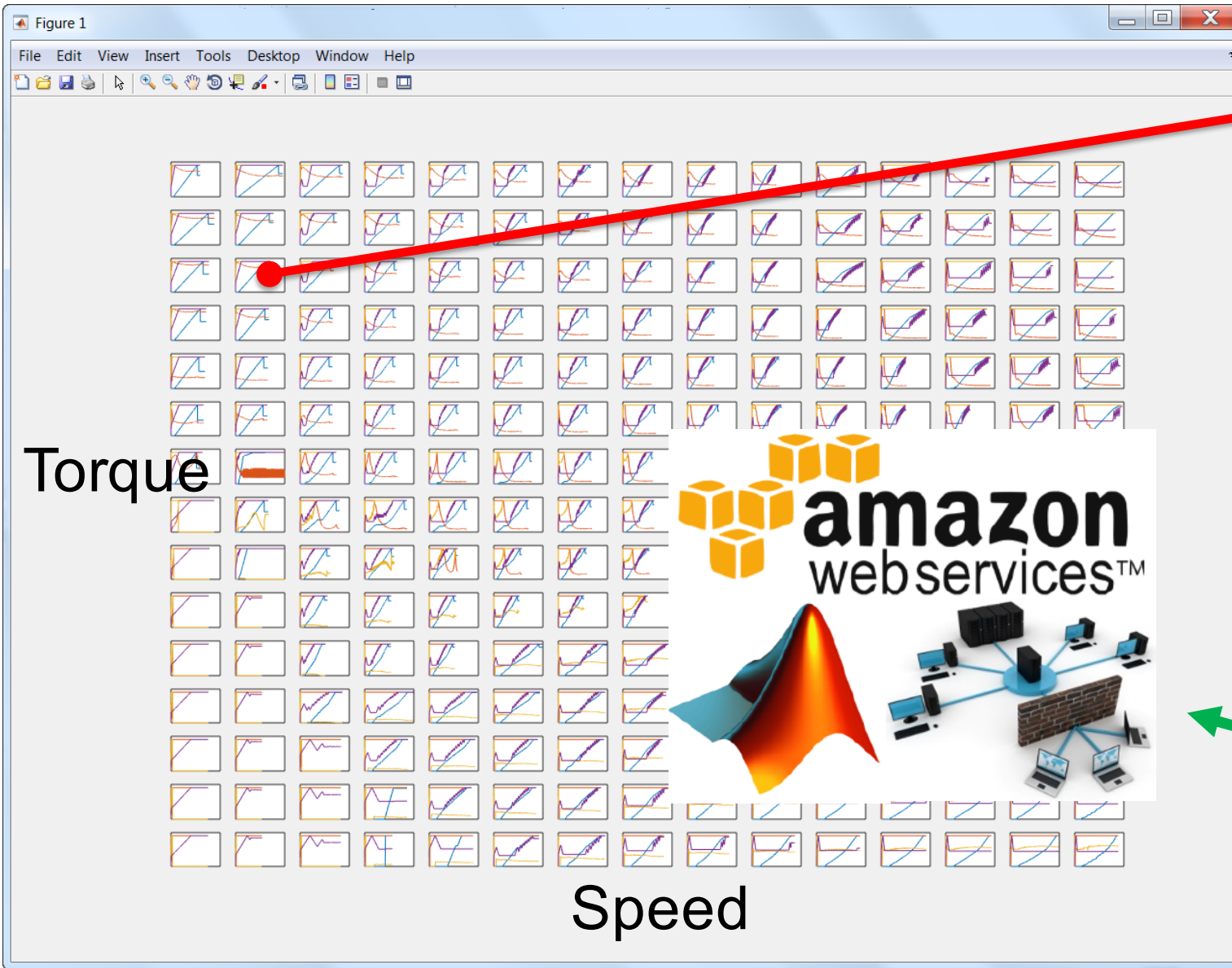

Table 3.6. Spark Advance															
	750	1054	1357	1661	1964	2268	2571	2875	3179	3482	3786	4089	4393	4696	5000
15	21	26	31	37	40	47	50	49	50	50	50	50	50	57	63
26	14	18	24	25	32	35	40	45	49	50	50	50	50	50	53
49	10	17	21	25	29	33	38	41	46	50	50	50	50	50	50
61	8	14	19	23	27	29	34	35	39	43	48	50	50	49	50
72	7	11	15	19	23	26	29	34	35	39	43	48	50	50	50
84	7	10	14	18	22	24	27	30	34	36	40	44	48	48	48
95	9	13	17	21	24	27	30	33	36	41	45	48	48	48	48
106	9	13	17	21	24	27	30	33	36	41	45	48	48	48	48
118	0	0	17	21	23	27	30	33	37	39	40	42	44	45	45
129	0	0	16	20	23	26	30	32	35	36	38	39	40	42	44
141	0	0	0	11	19	23	26	29	32	34	35	37	38	40	43
152	0	0	0	15	20	24	27	27	30	32	33	35	37	39	41
164	0	0	0	2	17	22	24	24	28	29	32	34	35	37	38
175	0	0	0	0	4	17	21	22	25	27	30	32	33	34	36

Table 3.7. Ignition Timing

Table 3.8. Lambda

Table 3.9. Intake Cam Phaser Angle

Table 3.10. Exhaust Cam Phaser Angle

Table 3.2. Throttle Position

Table 3.4. Wastegate Area

Table 3.5. Turbo Wastegate Area

Table 3.3. Air/Fuel Ratio

Table 3.1. Throttle Position

Table 3.0. Turbo Wastegate Area

Automated Base Engine Calibration Maps In 2hrs!

Summary

- Engine Calibration Is a Major Bottleneck in Engine Design Process
- VECO Process For SI Engine Removes Base Calibration Bottleneck
- VECO Is Practical For Everyday Use Due To Parallel Computing

Questions?